



HIRE AND RENTAL INDUSTRY ASSOCIATION LIMITED

EVENTS DIVISION

Temporary Structure / Marquee Weighting Guide

HIRE AND RENTAL INDUSTRY ASSOCIATION LIMITED

ACN: 093 630 847 ABN: 70 093 630 847

P O Box 1304 Mona Vale NSW 2103 Tel: 02 9997 5166 Fax: 02 9997 4485

Free-call 1800 01 5166 E-mail info@hireandrental.com.au Website www.hireandrental.com.au



EVENTS DIVISION

Temporary Structure / Marquee Weighting Guide

TABLE OF CONTENTS

Introduction

1. Weighting Guide
2. 3x3m & 4x4m Fete Stall Marquee – Weighted
3. 3x3m & 4x4m Fete Stall Marquee – Dyna bolts
4. 3m, 4m & 6m Structure – Weighted
5. 3m, 4m & 6m Structure – Dyna bolts
6. 8m, 9m & 10m Structure – Weighted
7. 8m, 9m & 10m Structure – Dyna bolts
8. 15x15m Weight Guidelines – Weighted
9. 15x15m Weight Guidelines – Dyna bolts
10. 20m Structure – Weighted
11. 20m Structure – Dyna bolts
12. 25m Structure – Weighted
13. 25m Structure – Dyna bolts
14. Sample weight box
15. Sample weight box with weights



HIRE AND RENTAL INDUSTRY ASSOCIATION LIMITED

ACN: 093 630 847 ABN: 70 093 630 847
P O Box 1304 Mona Vale NSW 2103 Tel: 02 9997 5166 Fax: 02 9997 4485
Free-call 1800 01 5166 E-mail info@hireandrental.com.au Website www.hireandrental.com.au

Issue No. 1
Feb 2009

INTRODUCTION

EVENTS DIVISION

Temporary Structure / Marquee Weighting Guide

This guide has been put together by concerned members of the Events Division of the HRIA Ltd, including manufacturers, suppliers, rental companies and end users. It has been produced to offer guidance with regards to the safety and stability of marquees or temporary structures in outdoor areas.

The traditional methods of stability have been pegging and weighting. However, in recent years, with the increasing focus on OH&S and regulations, it has become harder and harder to use pegging because of concerns for underground services and ground quality.

Weighting has become the favoured method of achieving safety and stability with temporary structures, particularly in outdoor public areas.

This guide attempts to give all members a realistic weight guide to ensure the structure is safe. The easy to read table is based on Terrain Category TC 2.5, which covers the majority of locations. The chart defines, through bay size and width, the weight required for each leg. Also included are a number of drawings and photos showing typical methods of attaching the weights and boxes to the legs.

Members of the HRIA Events Division work to this standard as a general guide and are encouraged to share this information with other interested parties such as councils and event venues.

Feedback is welcomed. Please contact the HRIA by email: info@hireandrental.com.au or phone 1800 015166 if you wish to comment or suggest on the guide and its contents. It can be downloaded from the HRIA webpage.

As with all guides of this nature your attention is drawn to the disclaimer. Also remember that you are responsible for OH&S, so if in doubt please consult the appropriate competent persons or engineer if you feel unsure about terrain or wind rating or location.

We hope you find the document useful and relevant.

Phil Newby
HRIA Ltd CEO

Geoff Tucker
Events Division President



HIRE AND RENTAL INDUSTRY ASSOCIATION LIMITED

ACN: 093 630 847 ABN: 70 093 630 847

P O Box 1304 Mona Vale NSW 2103 Tel: 02 9997 5166 Fax: 02 9997 4485

Free-call 1800 01 5166 E-mail info@hireandrental.com.au Website www.hireandrental.com.au

WEIGHTING GUIDE TABLE (Based on Terrain Category 2.5)

Terrain Category (TC) 2.5 has been used as (TC) 3 specifies numerous closely spaced obstructions. i.e. Terrain with moderately closely spaced obstructions 3m to 5m such as areas on the fringes of suburban areas and country towns.

NB: Check Terrain Category with Local Authorities or Engineer if in doubt.

STRUCTURE WIDTH (m)	BAY WIDTH (m)	WEIGHT PER LEG (kg)	OR	No. of DYNABOLTS PER LEG
3	1.5	120		1
3	3	120		1
4	3	200		1
5	3	200		2
6	3	200		2
7	3	225		2
8	3	225		2
9	3	225		2
10	3	250		2
10	5	700		3
12	5	1000		3
15	5	1200		4
20	5	1600		4
25	5	2000		4

NOTE:

- Maximum roof peak height of 10m used for design (includes structures erected on raised platforms), e.g. 0-10m is the same formula for wind speed calculations i.e. if the structure is on a raised area 3m high, the wind speed is calculated at the same speed as ground level.
- Design for roof only allows for maximum of 50% of the walling installed. This is worst case scenario.
- Maximum leg height of 3000mm.
- Terrain category multipliers $M_d=1.0$, $M_t=1.0$ & $M_s=0.85$ have been used for design.
- Roof pitch of 18 degrees used for design.
- Weights can be tied down from top of leg with tie-downs of capacity equal to hold down weight minimum.
- Dynabolt limitations – numbers stated are for M16 Dynabolts, 70mm min embedment, 155mm min spacings, min edge distance on slab 80mm.
- Min structural thickness of slab for Dynabolt fixing of 110mm & min concrete strength of $F'c=25MPa$.
- To reduce slippage it is suggested that a carpet tile or rubber mat be placed under the foot-plate weight. This will also serve to protect the venue surface.
- Where structures are located side by side the weight guidelines per leg still need to be followed.
- These guidelines are a guide only.** For structure model and make specific loadings seek advice from the manufacturer or your structural engineer.
- Various weight systems can be used as long as they are directly attached to the structure. See examples attached or as specified by the manufacturer.
- Hire and Rental Industry Association Disclaimer:** This weighting guide has been produced for the use of Hire & Rental Industry Association Ltd members to offer guidance on the aspects of weighting structures as per the document. The information contained in the guide may be changed from time to time without notice. Members may verify the currency of the guide by contacting the HRIA Ltd directly by phone 02 9997 5166 or email info@hireandrental.com.au. The information contained within does not replace or replicate existing instructions, procedures, manuals, warnings or other programs available to owners or users of temporary structures. All information in the guide is given in good faith and is derived from sources believed to be accurate. However, the HRIA Ltd makes no representation as to the accuracy or completeness of this information and takes no responsibility for any damages or losses resulting from the use of the guide.

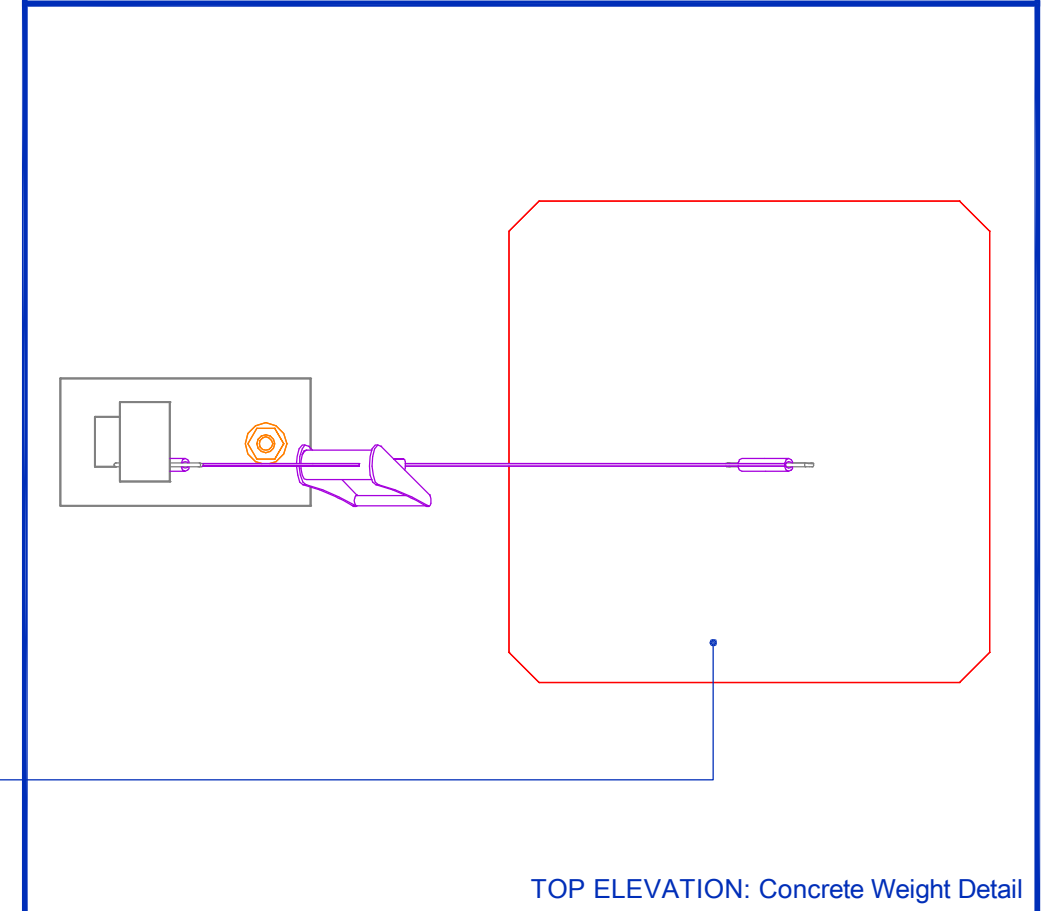
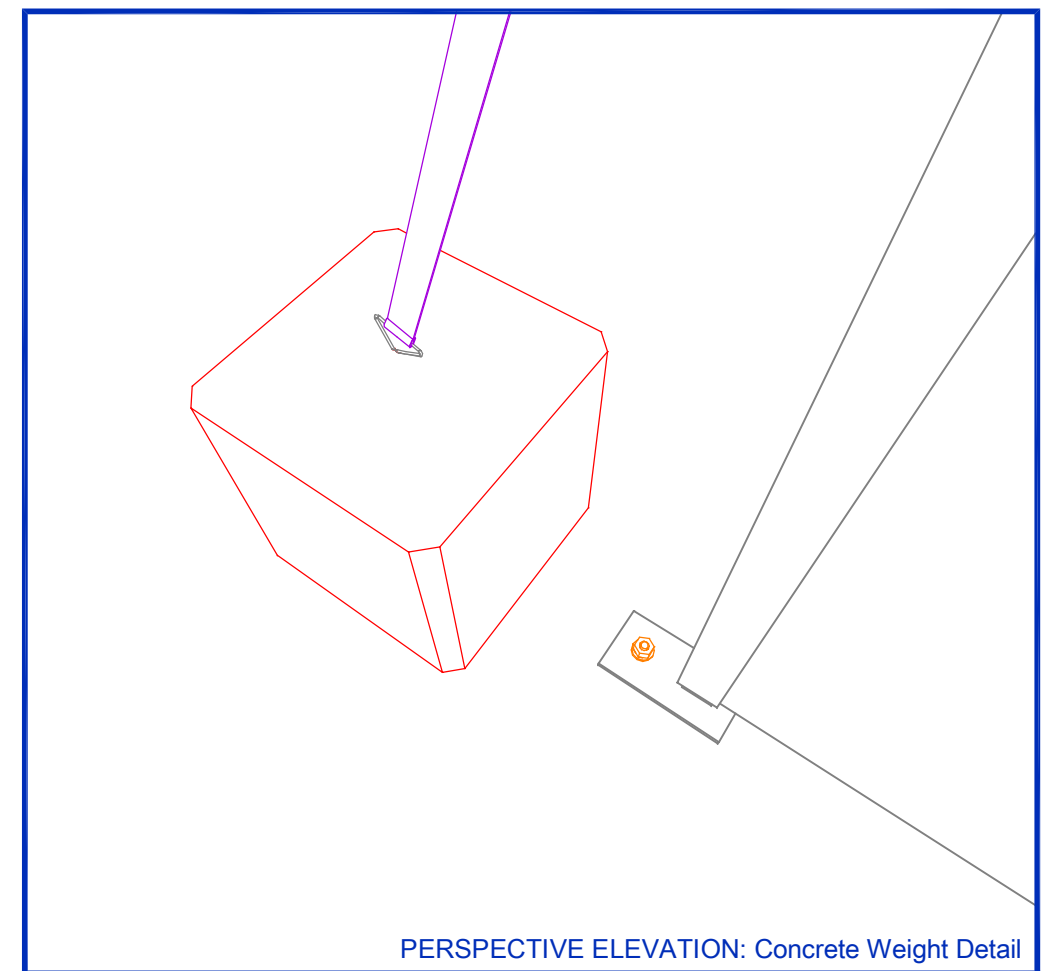
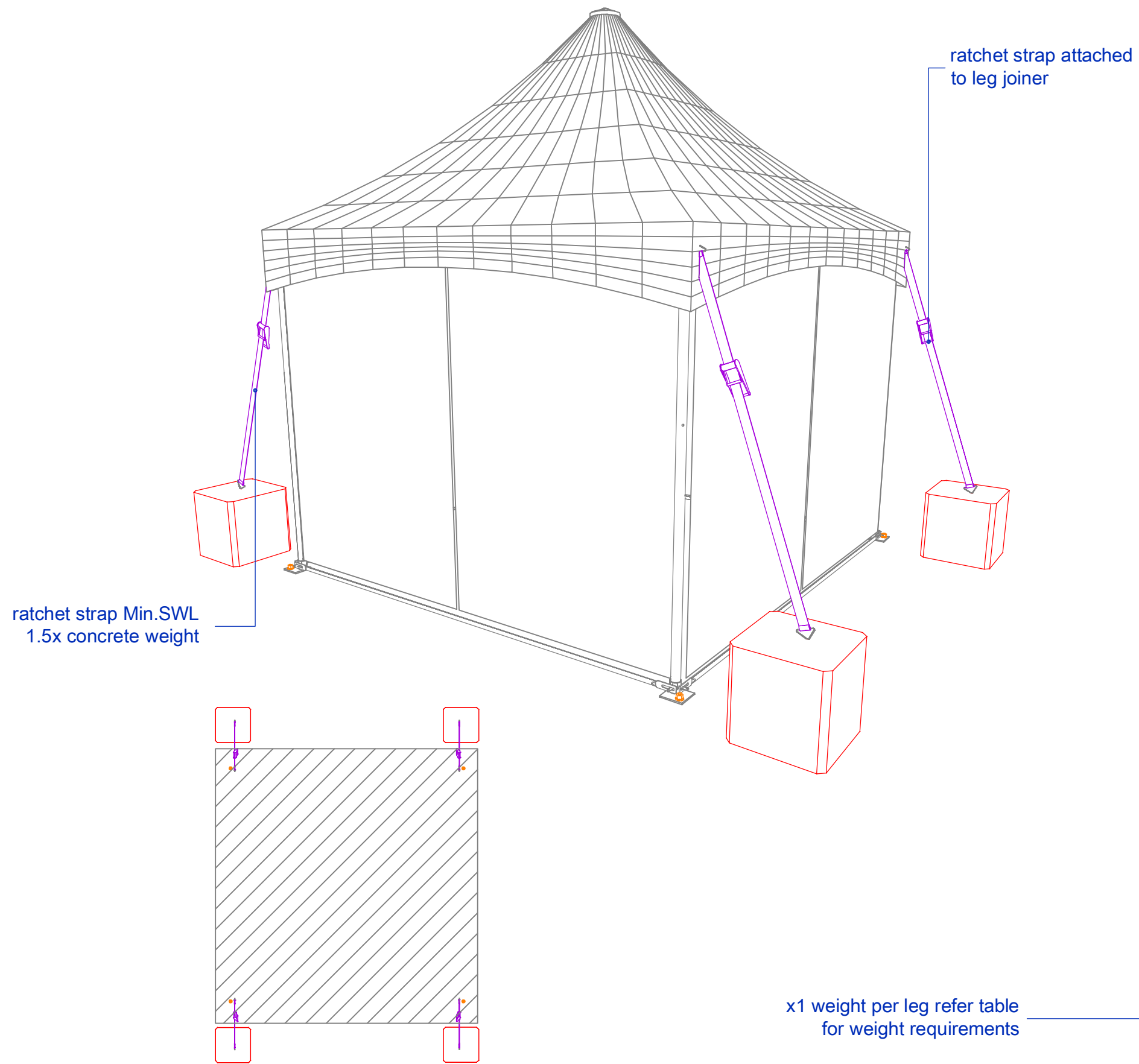

3x3m & 4x4m FETE STALL_MARQUEE



Revised: James Weeding	Rev Date: 18/04/08	Revision: 2
Drawn: James Weeding	Dwn Date: 15/04/08	Scale: NTS A3
U:\Structures\...HRIA Structure Weighting Guidelines\HRIA Structure Weighting Guidelines.dwg		

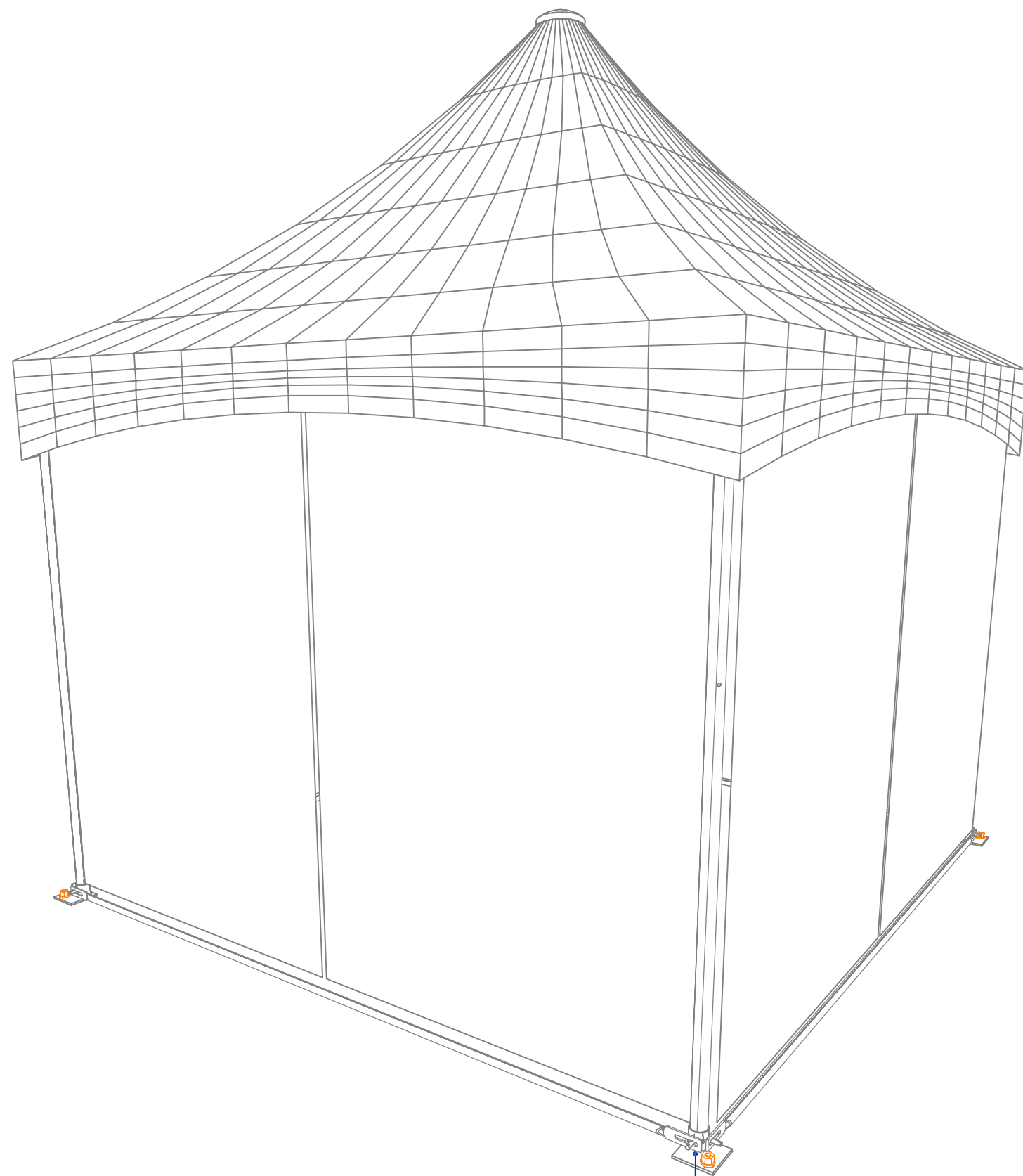

x1 M16 Dyna bolts OR
x1 Structure pegs
every footplate

M16 Dyna bolts minimum
embedment 85mm

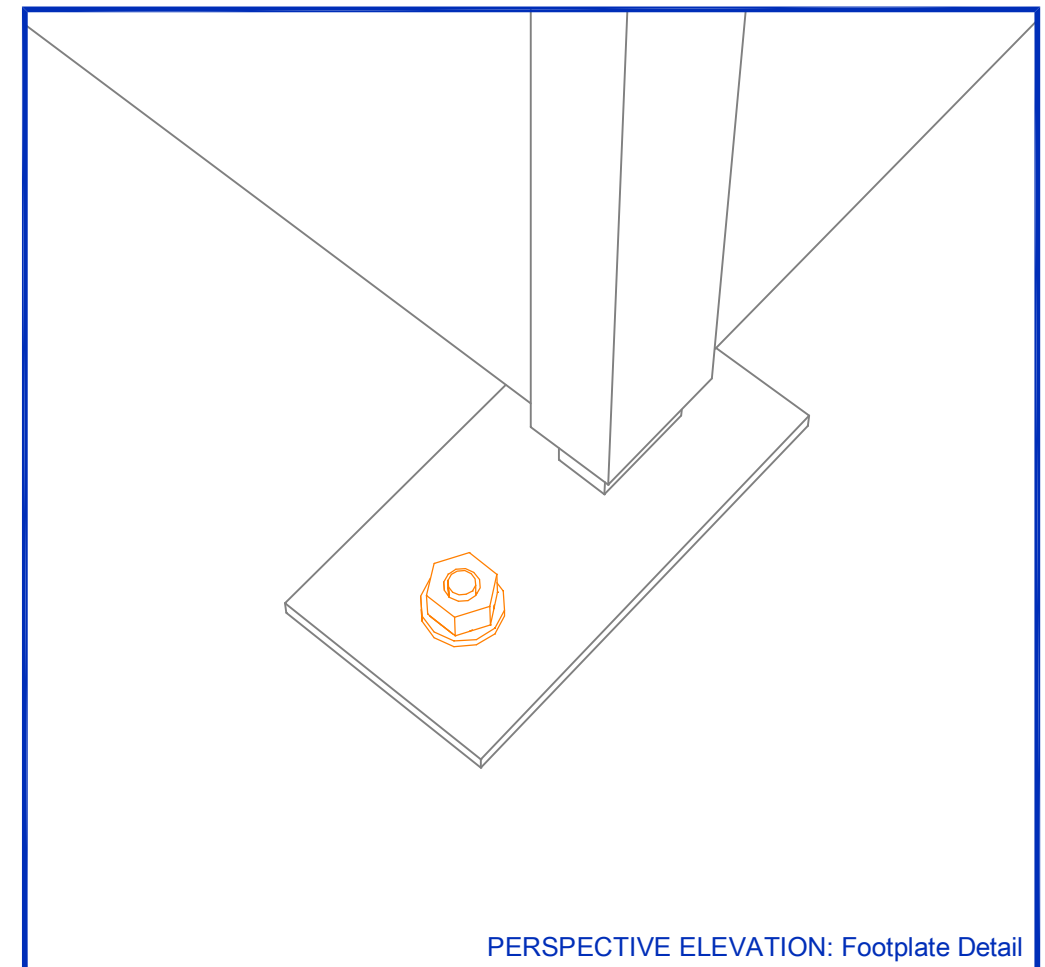

PERSPECTIVE ELEVATION: Footplate Detail

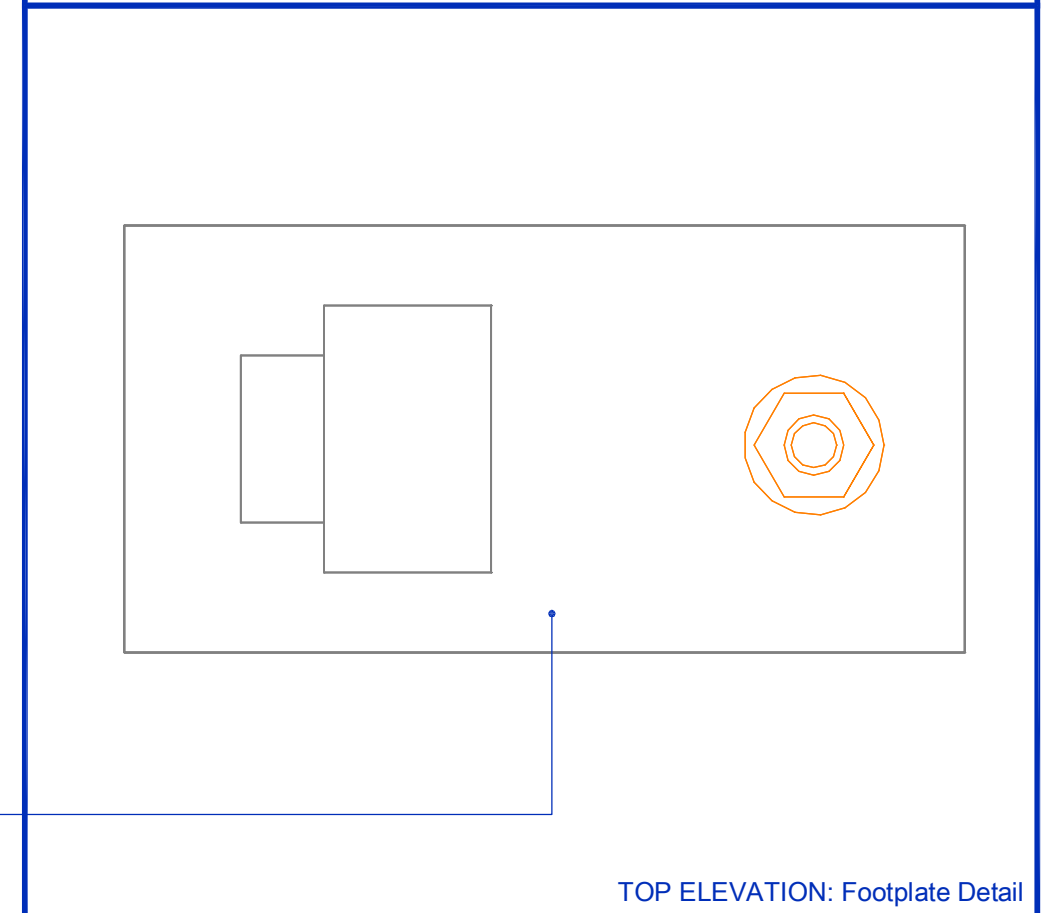

TOP ELEVATION: Footplate Detail

3x3m & 4x4m FETE STALL_MARQUEE (2)



Revised: James Weeding	Rev Date: 18/04/08	Revision: 2
Drawn: James Weeding	Dwn Date: 15/04/08	Scale: NTS A3
U:\Structures\...HRIA Structure Weighting Guidelines\HRIA Structure Weighting Guidelines.dwg		

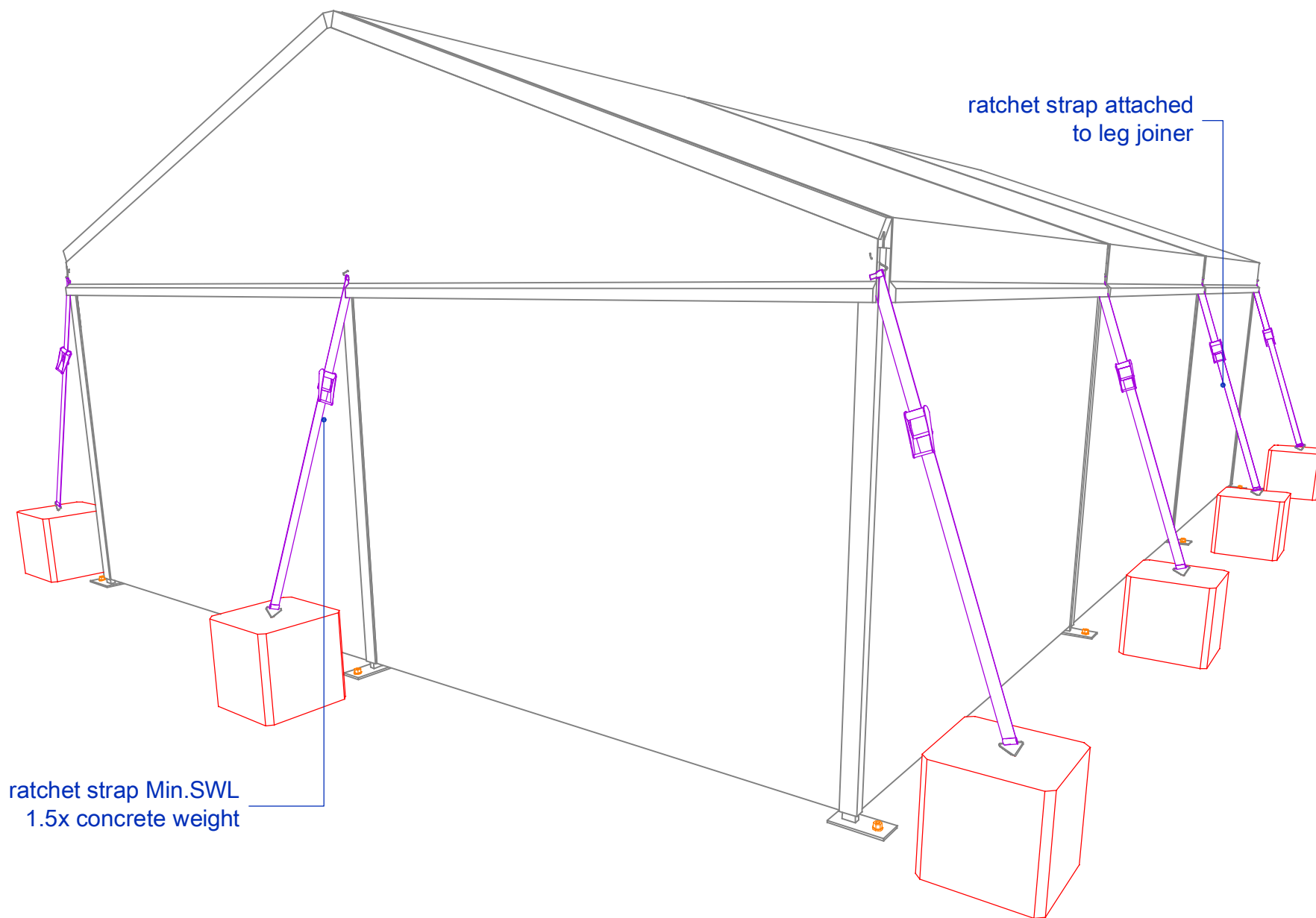

ratchet strap Min.SWL
1.5x concrete weight

ratchet strap attached to
leg joiner

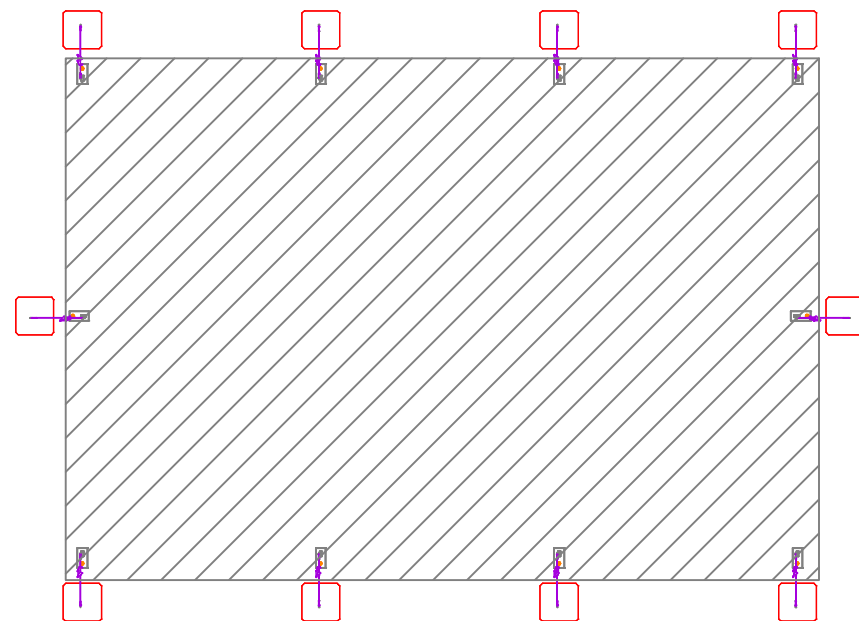

x1 weight per leg refer table
for weight requirements

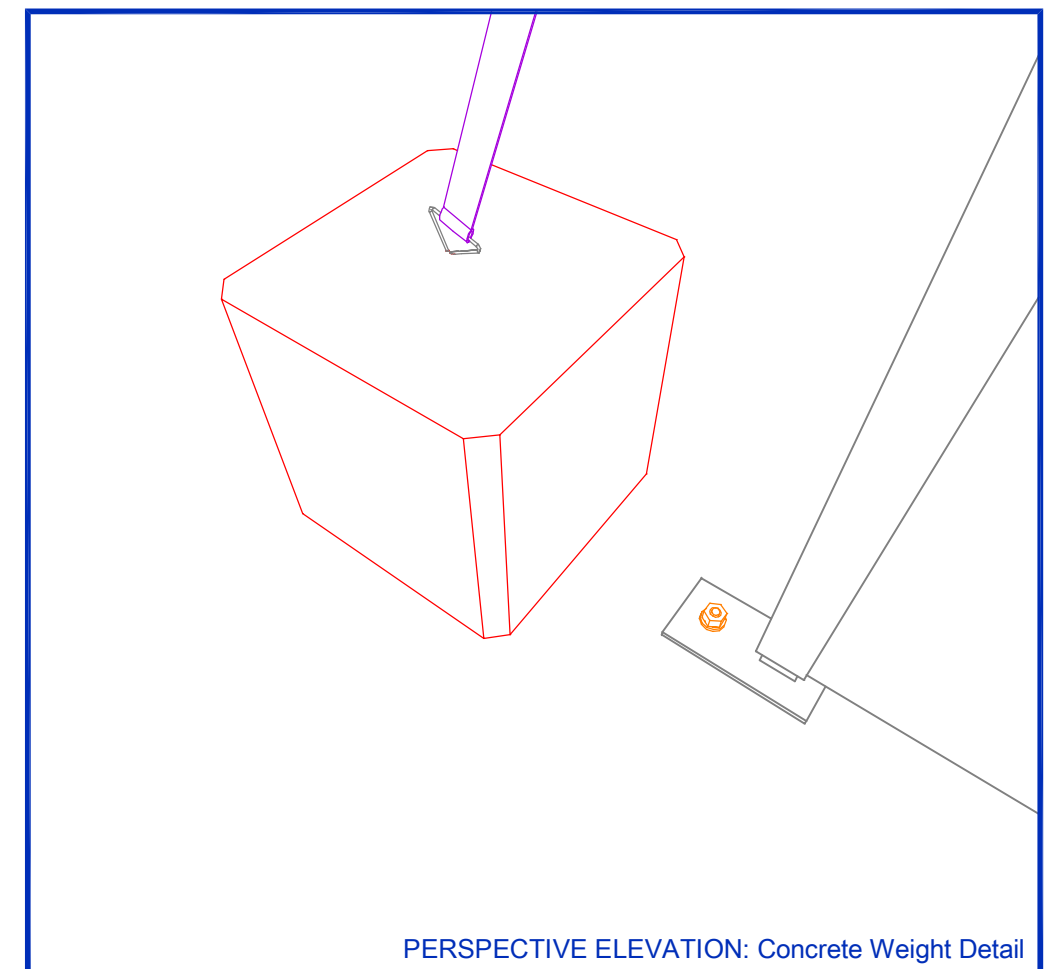

PERSPECTIVE ELEVATION: Concrete Weight Detail

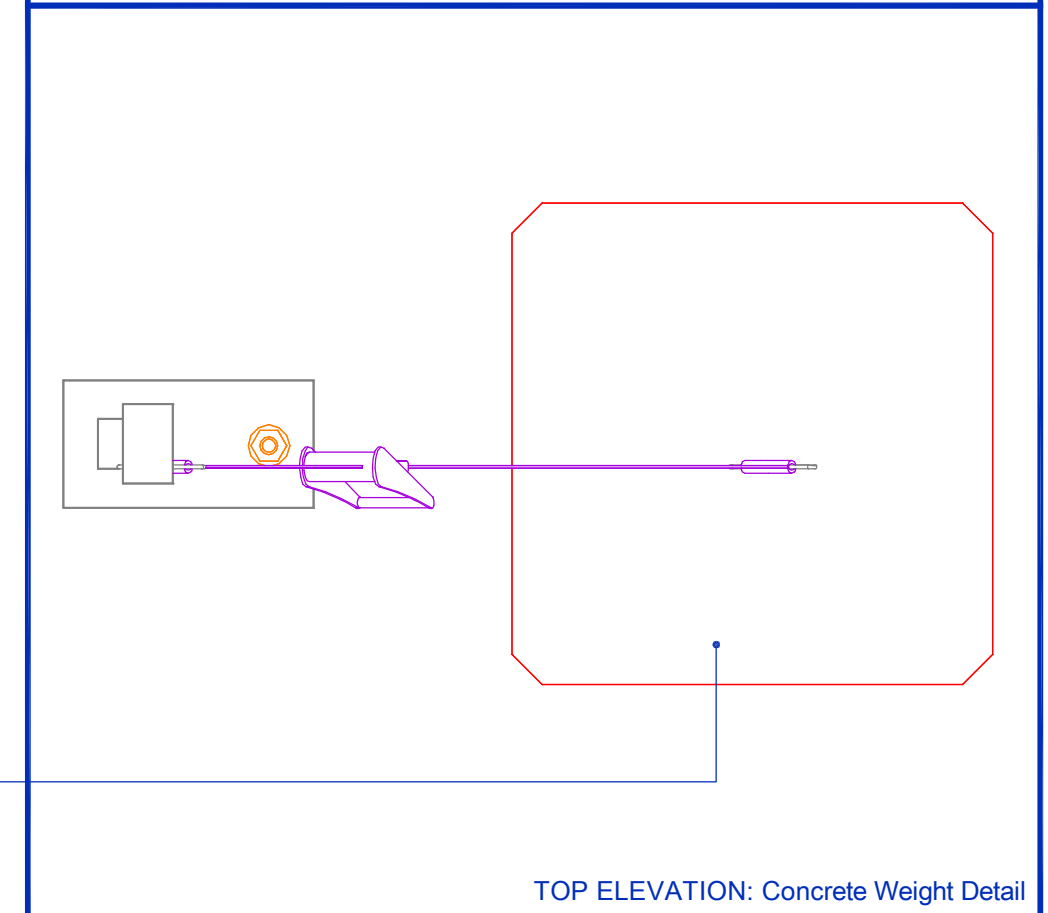

TOP ELEVATION: Concrete Weight Detail

3m_4m&6m STRUCTURE



Revised: James Weeding	Rev Date: 18/04/08	Revision: 2
Drawn: James Weeding	Dwn Date: 15/04/08	Scale: NTS A3
U:\Structures\...HRIA Structure Weighting Guidelines\HRIA Structure Weighting Guidelines.dwg		

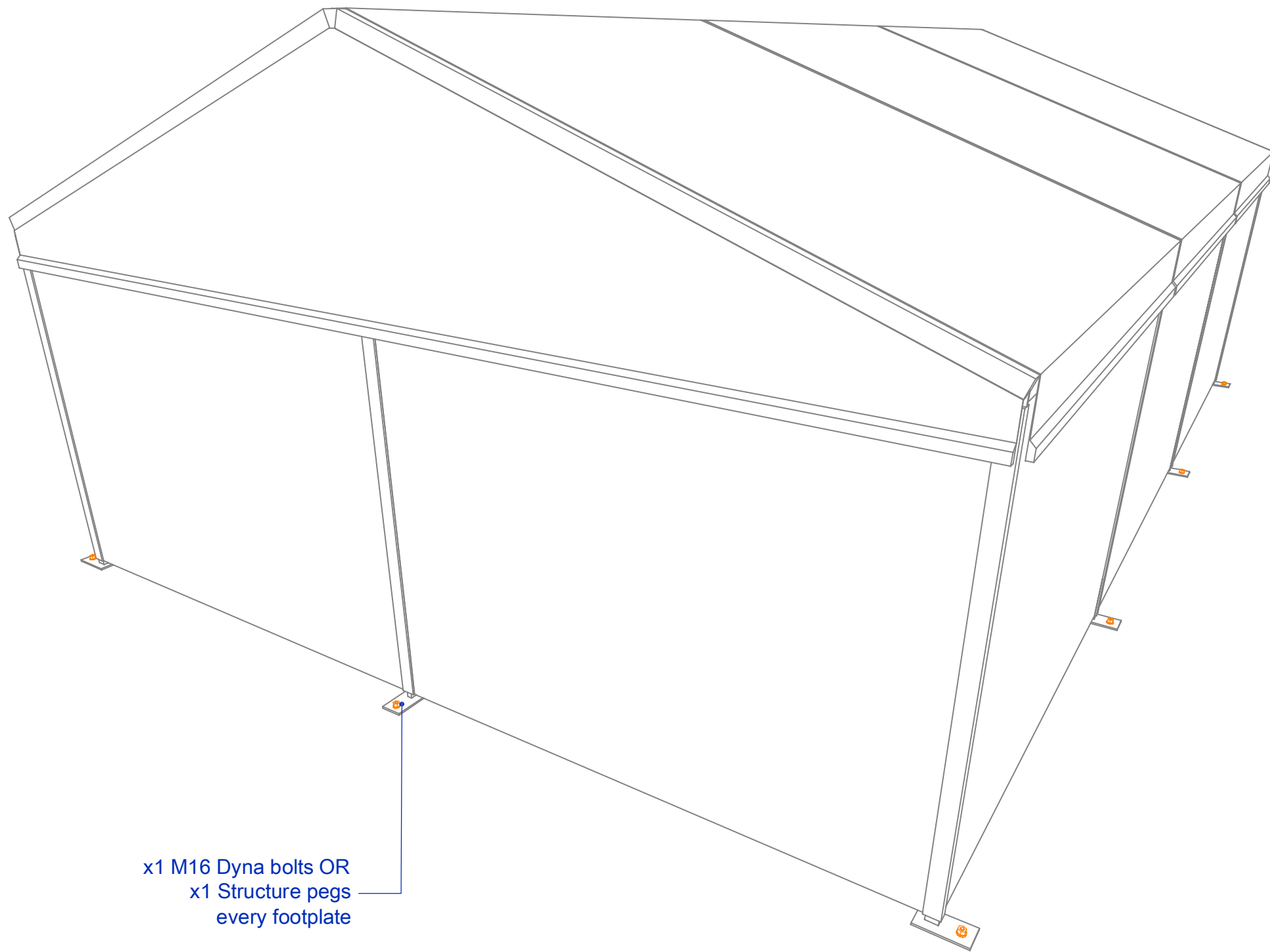

x1 M16 Dyna bolts OR
x1 Structure pegs
every footplate

M16 Dyna bolts minimum
embedment 85mm

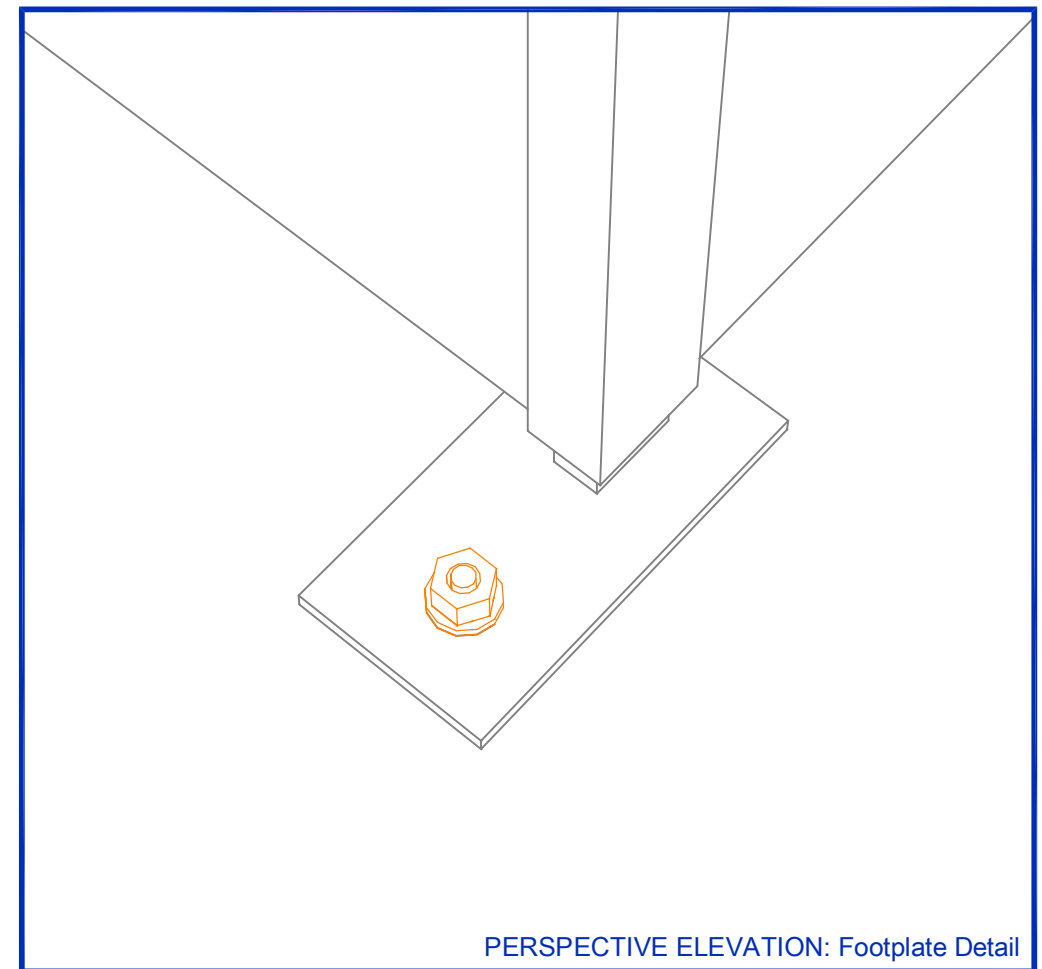

PERSPECTIVE ELEVATION: Footplate Detail

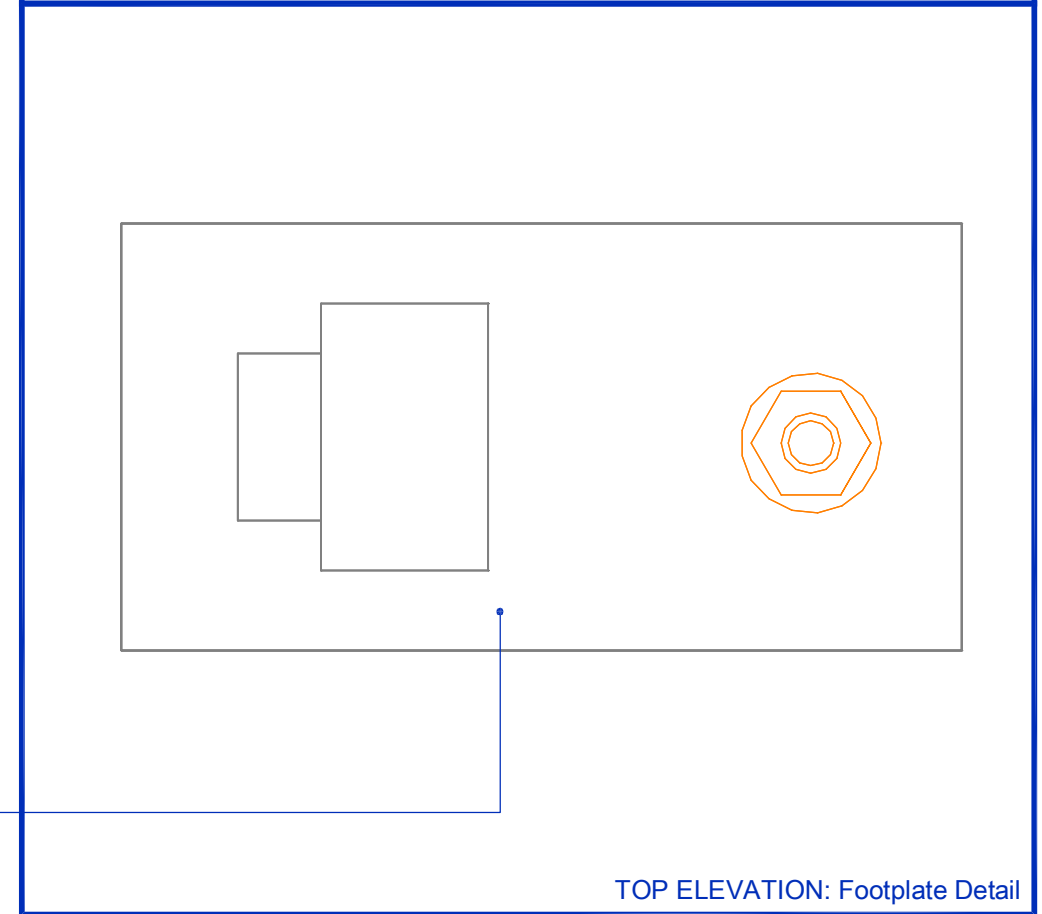

TOP ELEVATION: Footplate Detail

3m_4m&6m STRUCTURE (2)



Revised: James Weeding	Rev Date: 18/04/08	Revision: 2
Drawn: James Weeding	Dwn Date: 15/04/08	Scale: NTS A3
U:\Structures\...HRIA Structure Weighting Guidelines\HRIA Structure Weighting Guidelines.dwg		

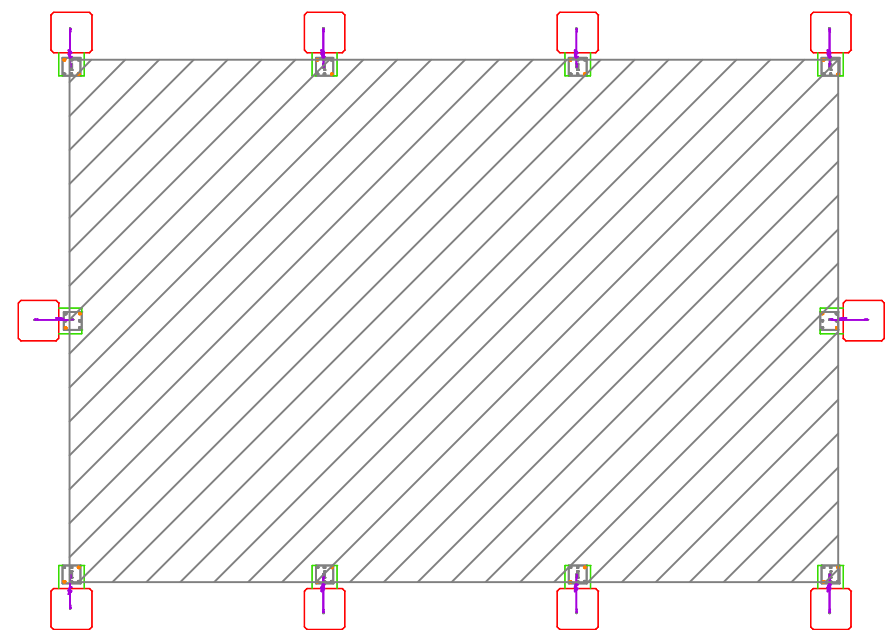
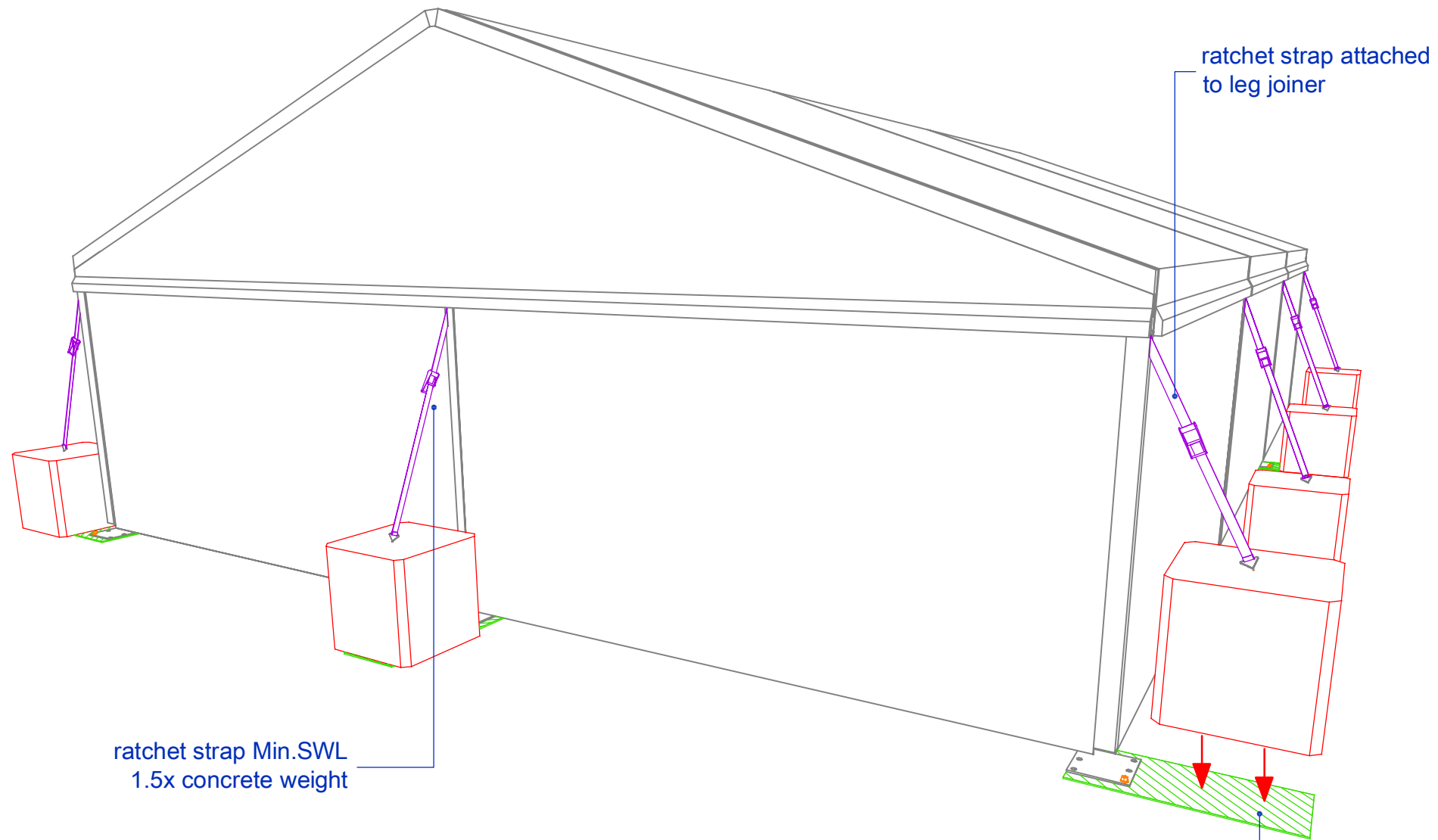

weight sits on plate bolted to footplate

x1 weight per leg refer table for weight requirements

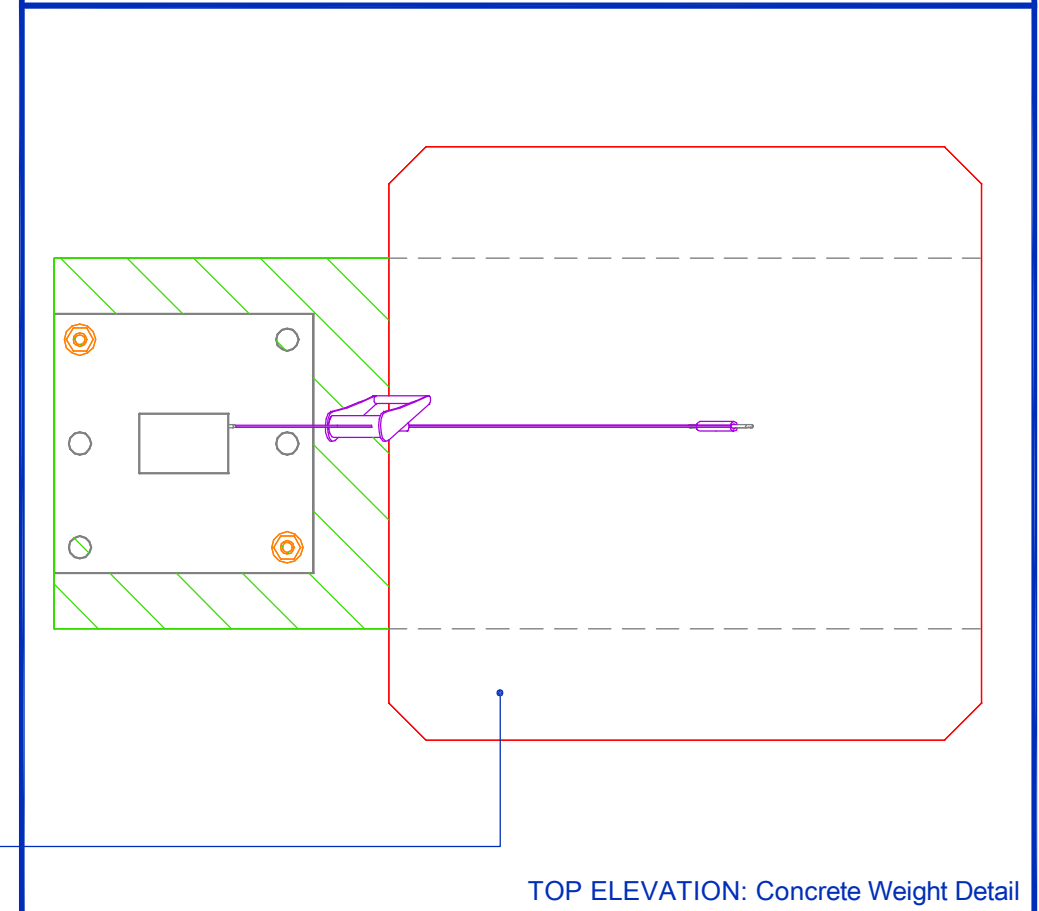
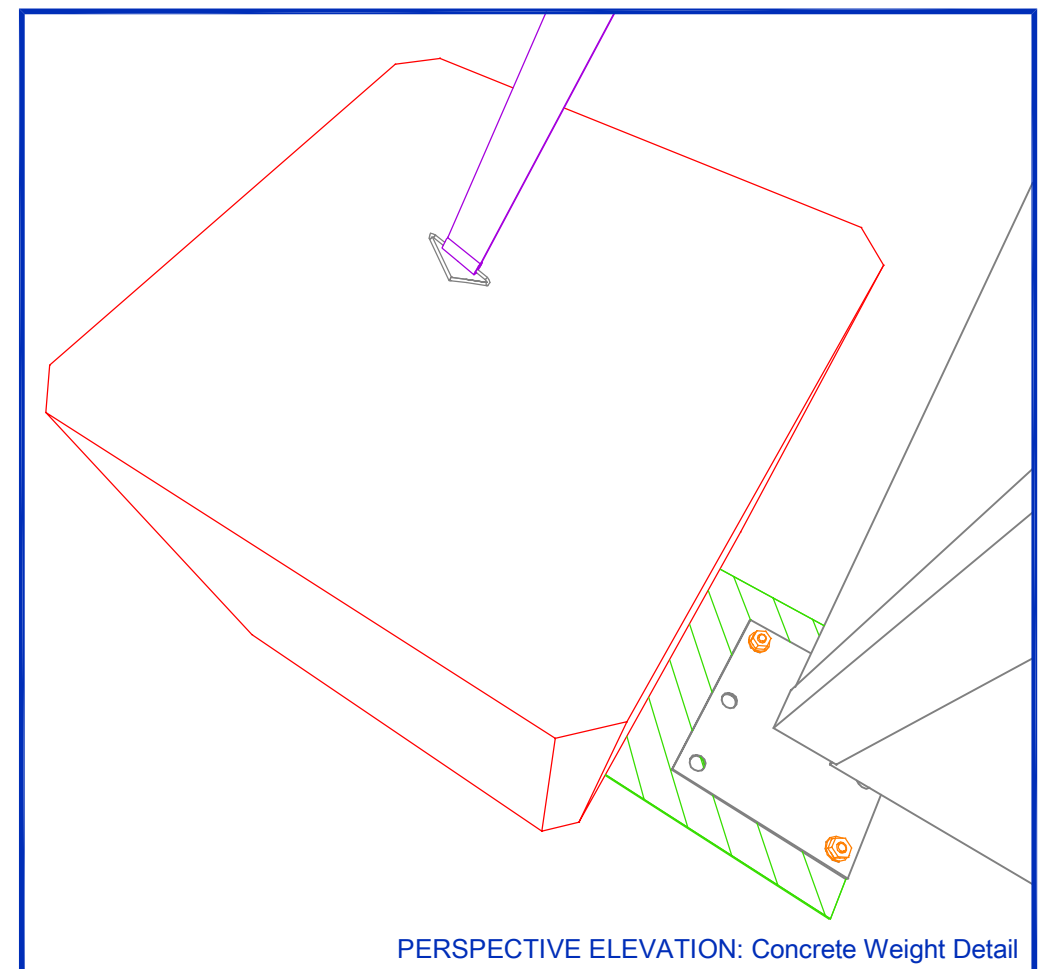

8m_9m&10m STRUCTURE



Revised: James Weeding	Rev Date: 18/04/08	Revision: 2
Drawn: James Weeding	Dwn Date: 15/04/08	Scale: NTS A3
U:\Structures\...HRIA Structure Weighting Guidelines\HRIA Structure Weighting Guidelines.dwg		

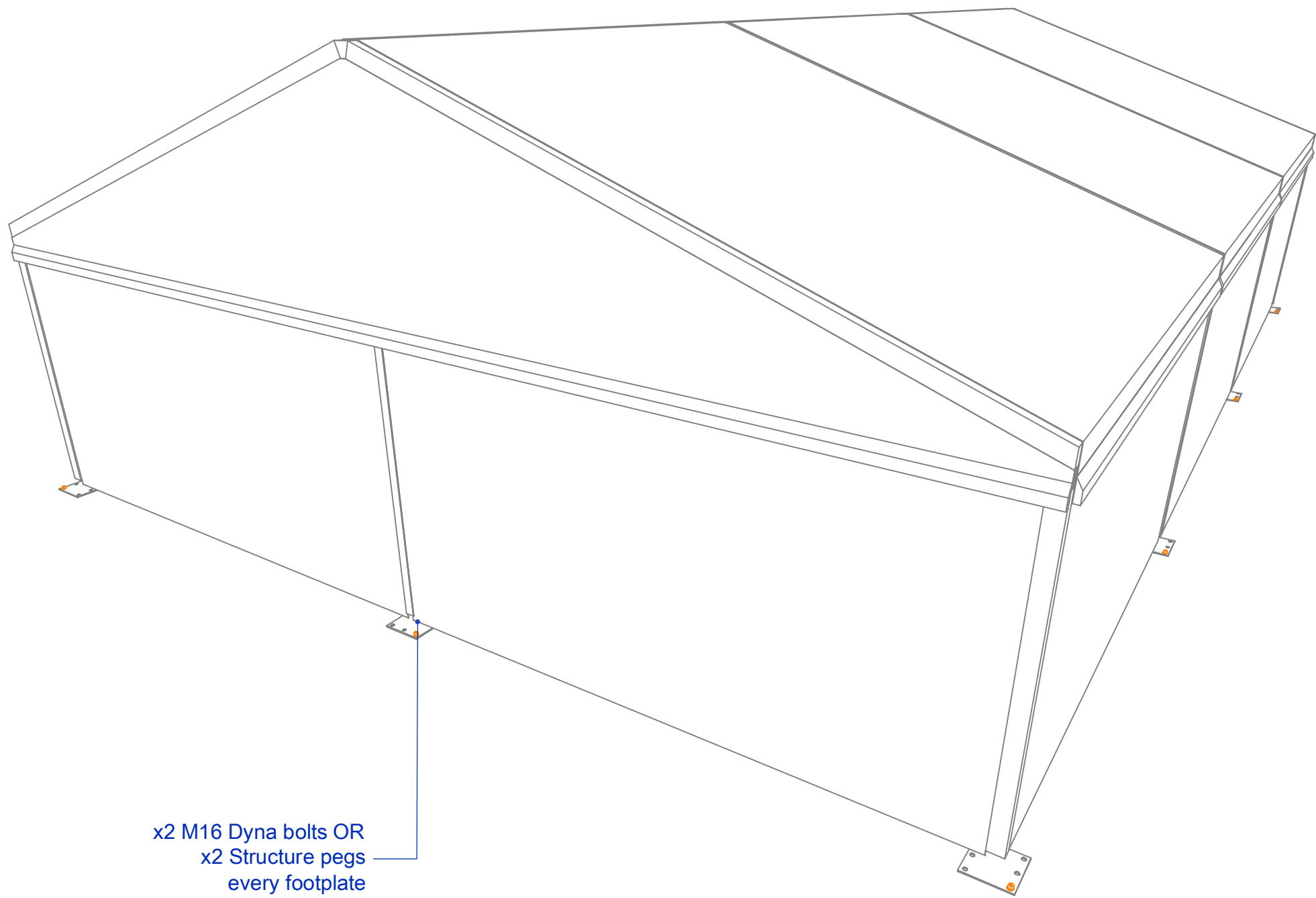

x2 M16 Dyna bolts OR
x2 Structure pegs
every footplate

M16 Dyna bolts minimum
embedment 85mm

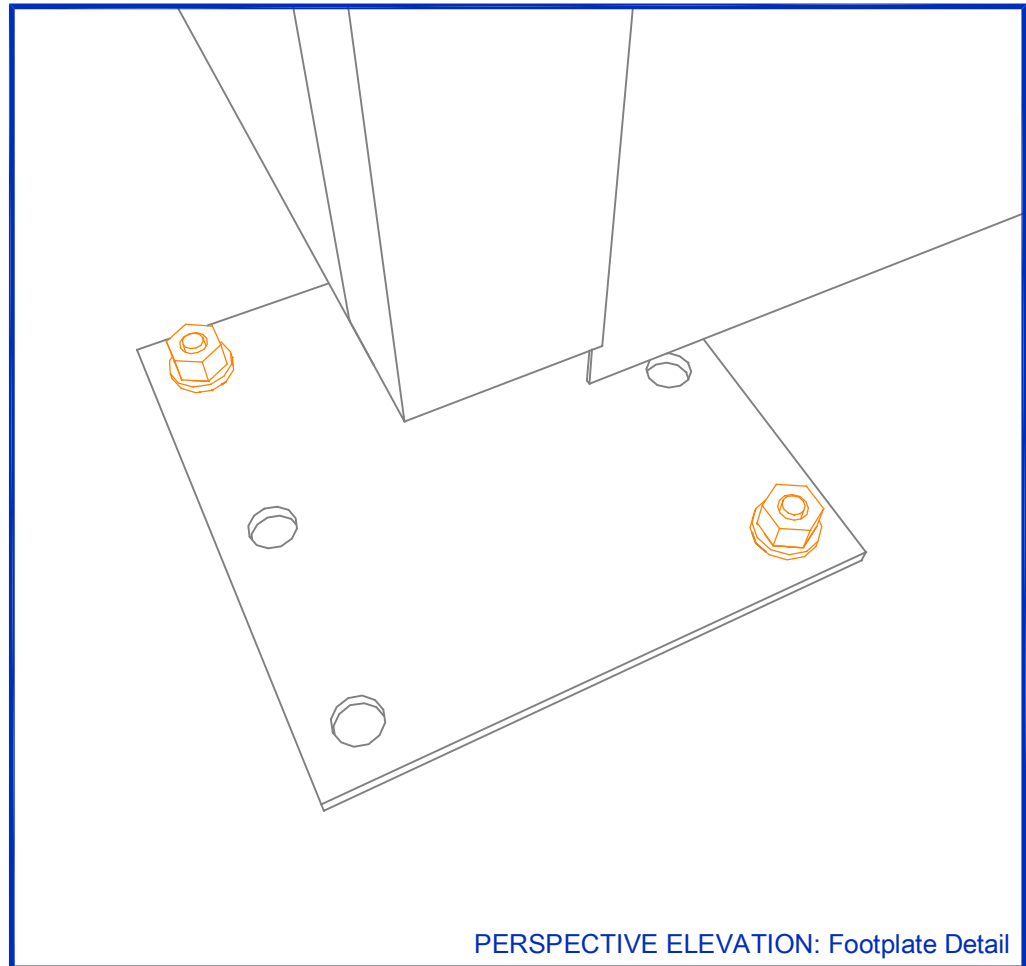

PERSPECTIVE ELEVATION: Footplate Detail

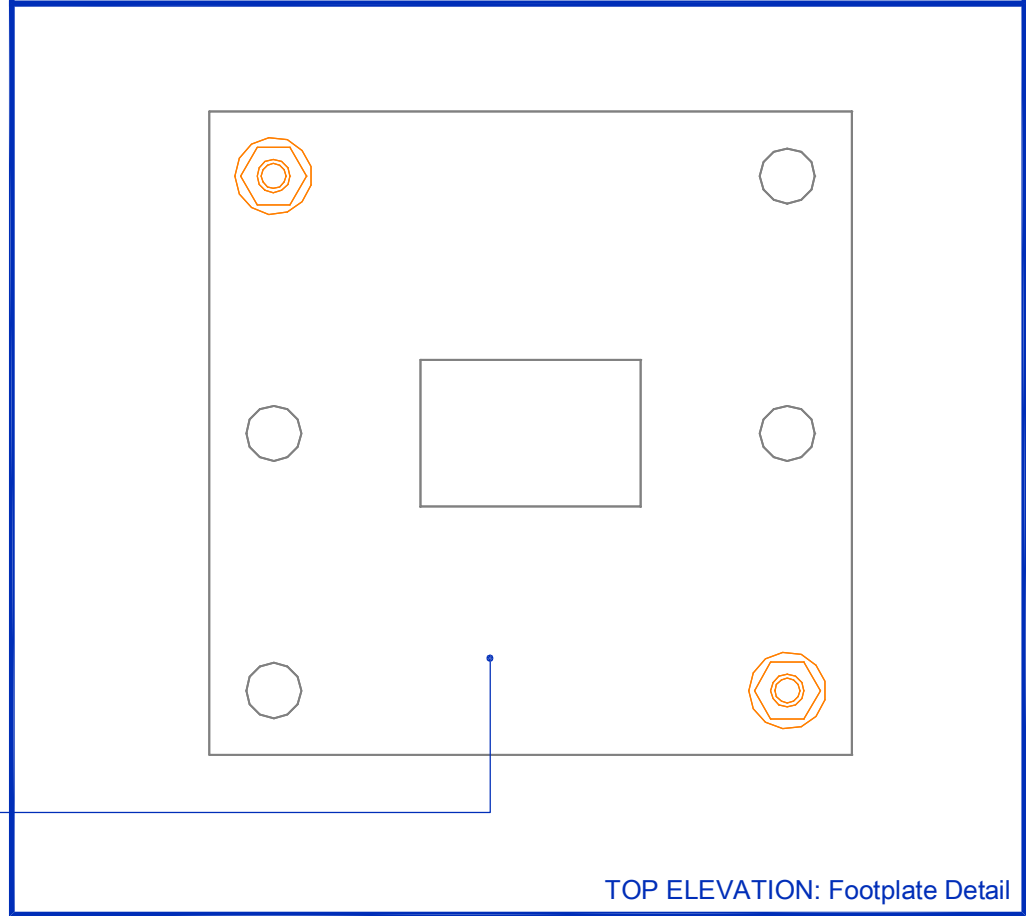

TOP ELEVATION: Footplate Detail

8m_9m&10m STRUCTURE (2)



Revised: James Weeding	Rev Date: 18/04/08	Revision: 2
Drawn: James Weeding	Dwn Date: 15/04/08	Scale: NTS A3
U:\Structures\...HRIA Structure Weighting Guidelines\HRIA Structure Weighting Guidelines.dwg		

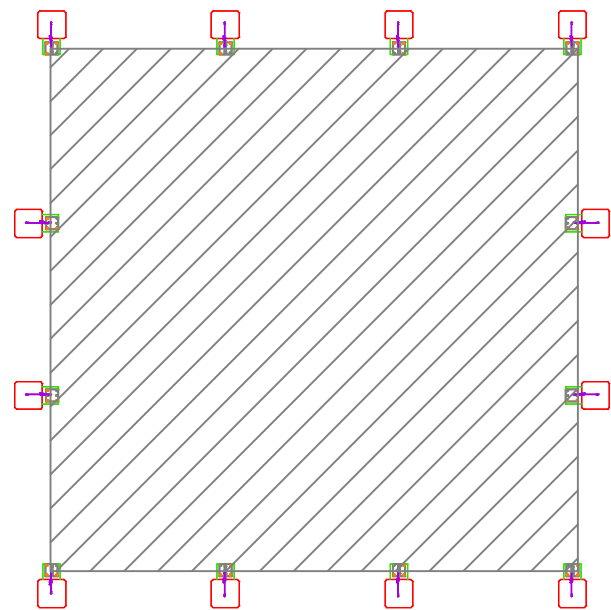
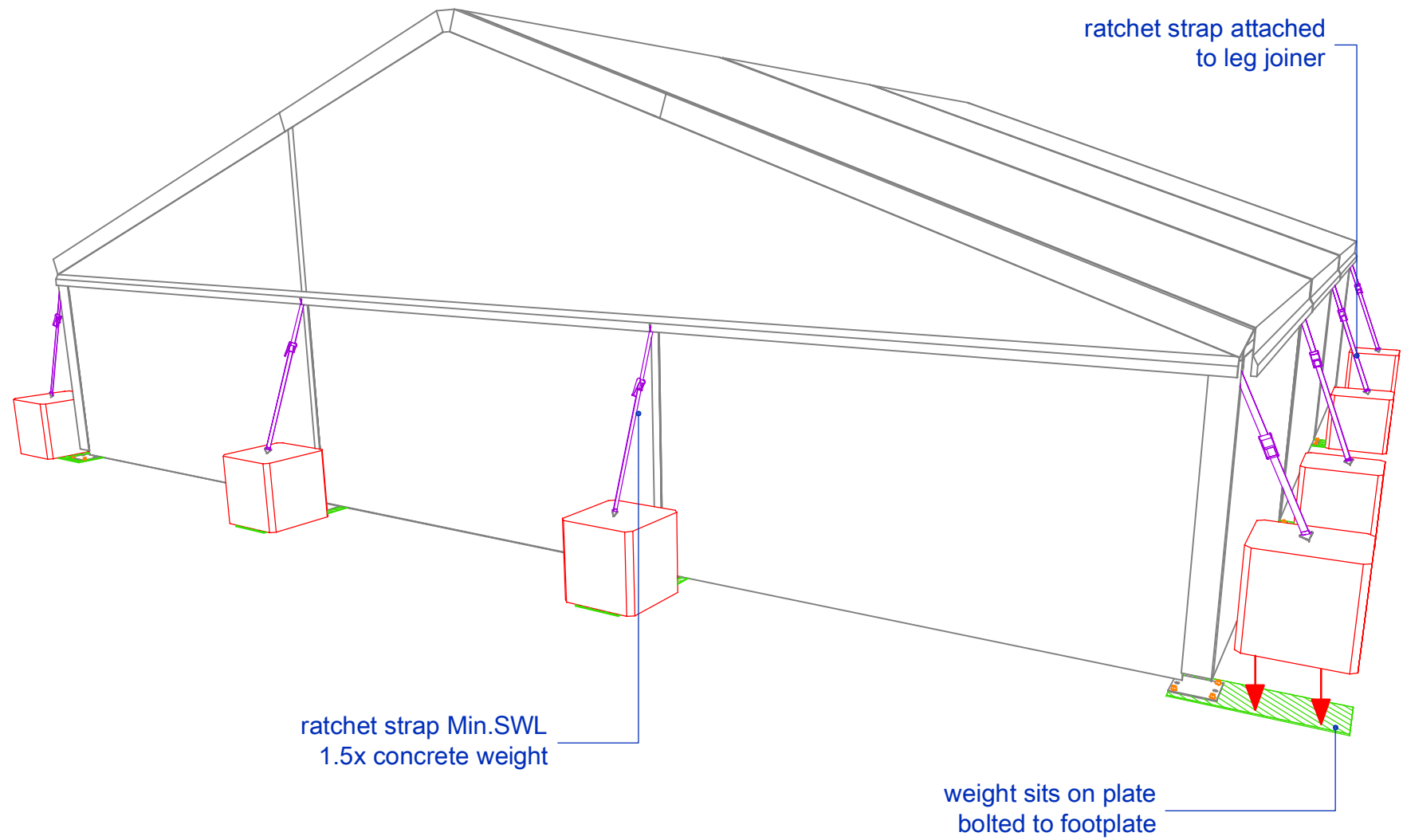

x1 weight per leg refer table for weight requirements

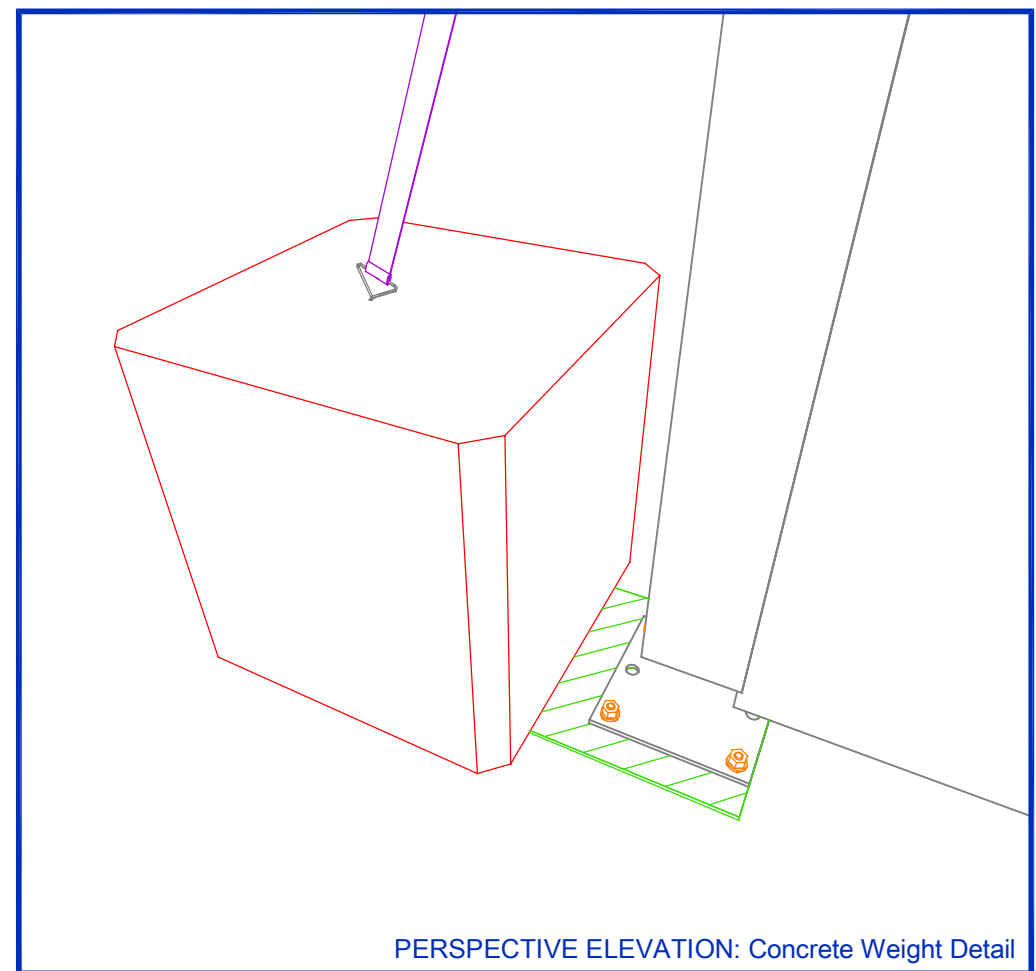

PERSPECTIVE ELEVATION: Concrete Weight Detail

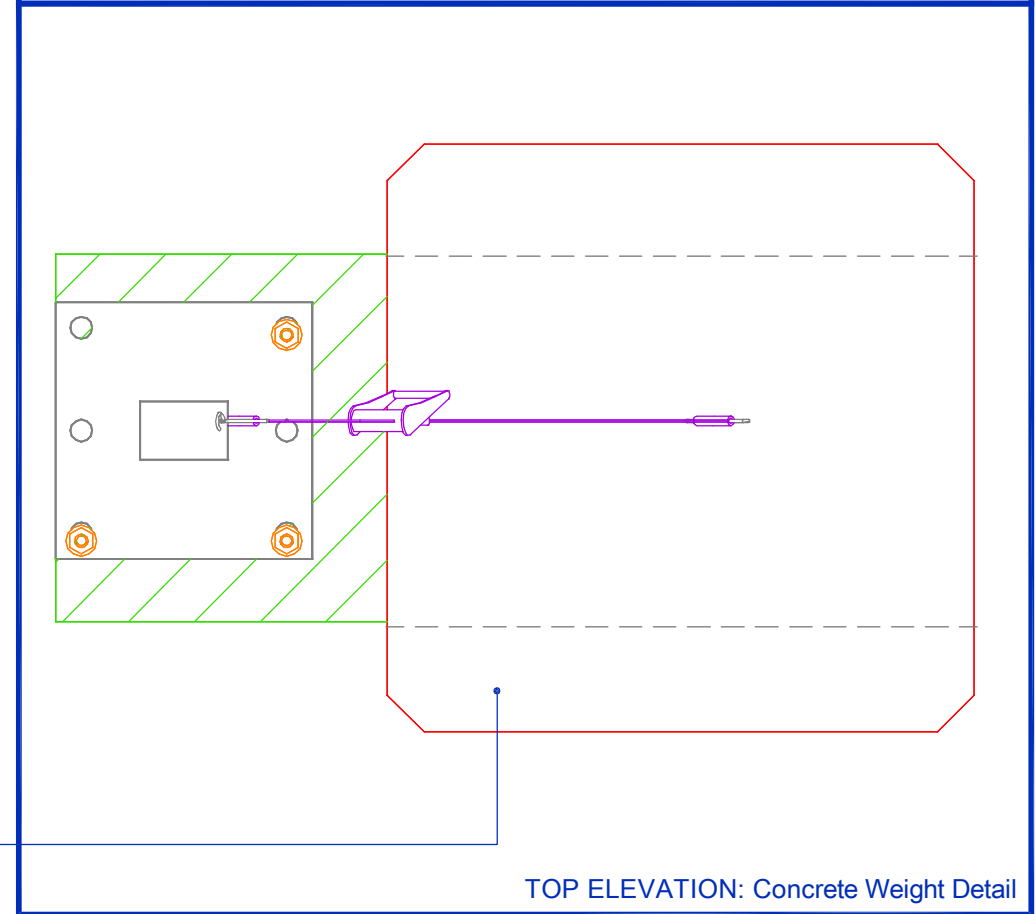

TOP ELEVATION: Concrete Weight Detail

15x15m WEIGHT GUIDELINES



Revised: James Weeding	Rev Date: 18/04/08	Revision: 2
Drawn: James Weeding	Dwn Date: 15/04/08	Scale: NTS A3
U:\Structures\...HRIA Structure Weighting Guidelines\HRIA Structure Weighting Guidelines.dwg		

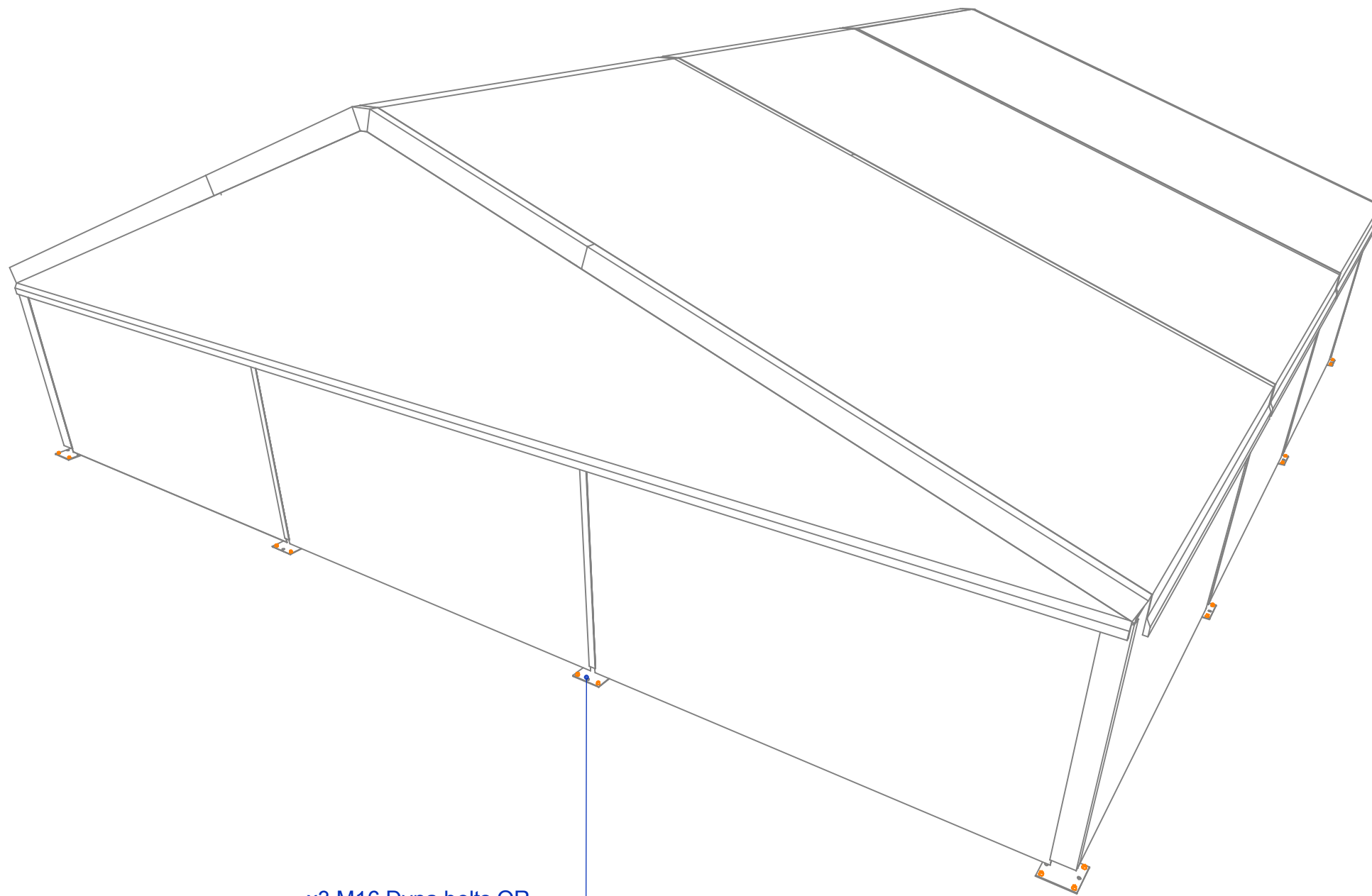

x3 M16 Dyna bolts OR
x3 Structure pegs
every footplate

M16 Dyna bolts minimum
embedment 85mm

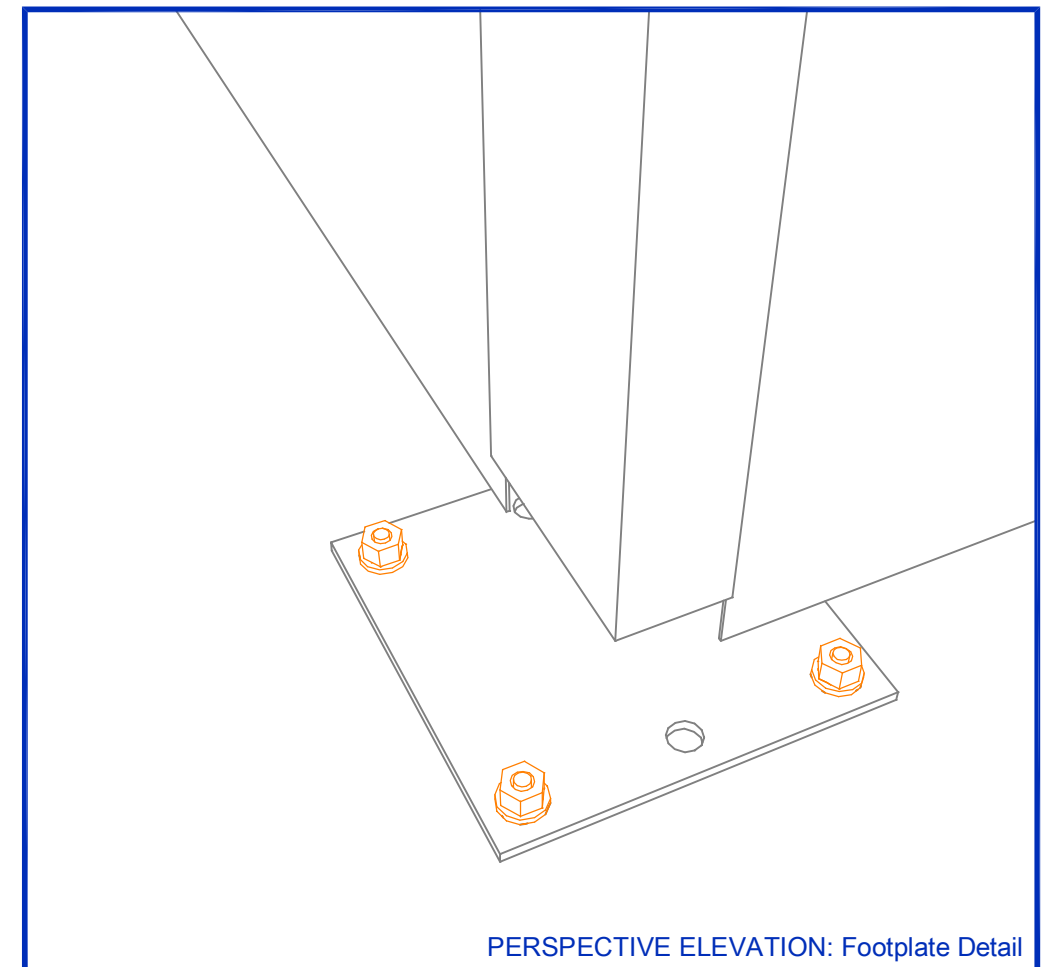

PERSPECTIVE ELEVATION: Footplate Detail

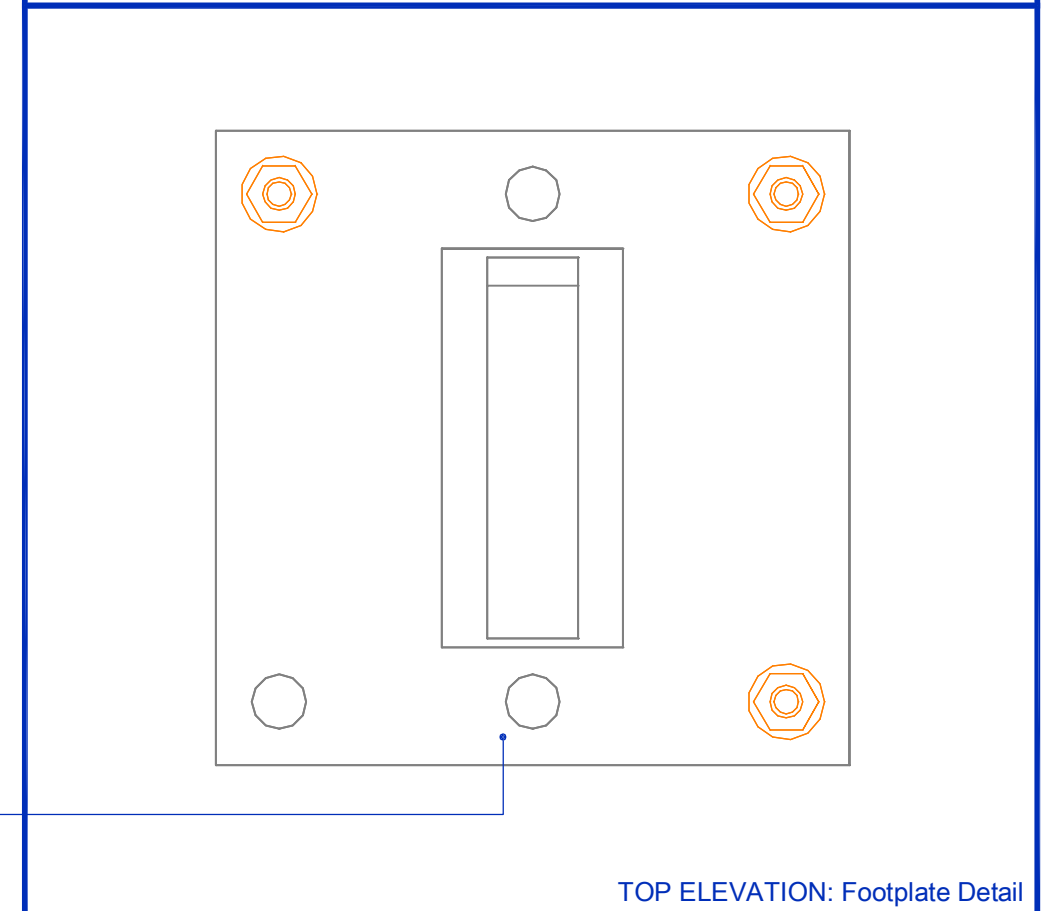

TOP ELEVATION: Footplate Detail

15x15m WEIGHT GUIDELINES (2)



Revised: James Weeding	Rev Date: 18/04/08	Revision: 2
Drawn: James Weeding	Dwn Date: 15/04/08	Scale: NTS A3
U:\Structures\...HRIA Structure Weighting Guidelines\HRIA Structure Weighting Guidelines.dwg		

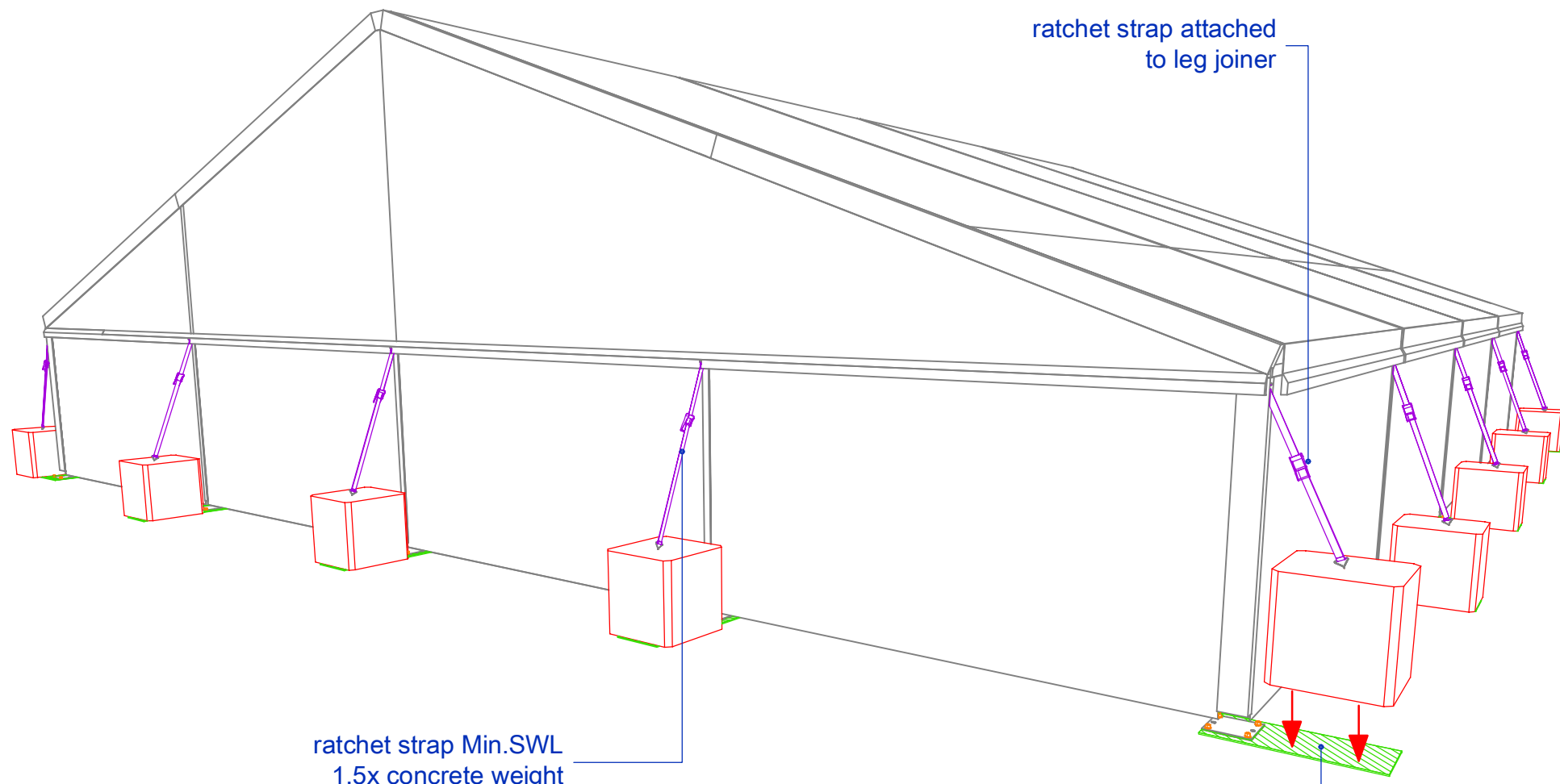

ratchet strap Min.SWL
1.5x concrete weight

ratchet strap attached
to leg joiner

weight sits on plate
bolted to footplate

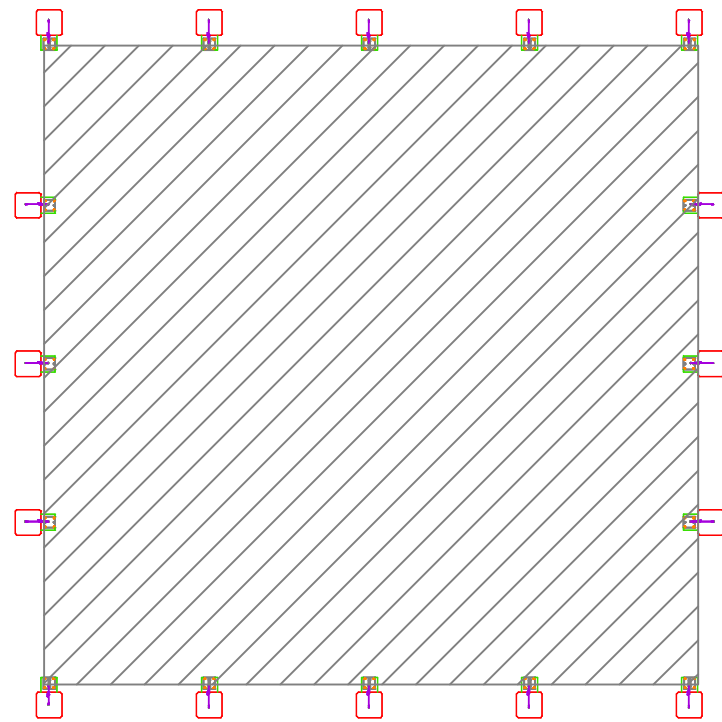

x1 weight per leg refer table
for weight requirements

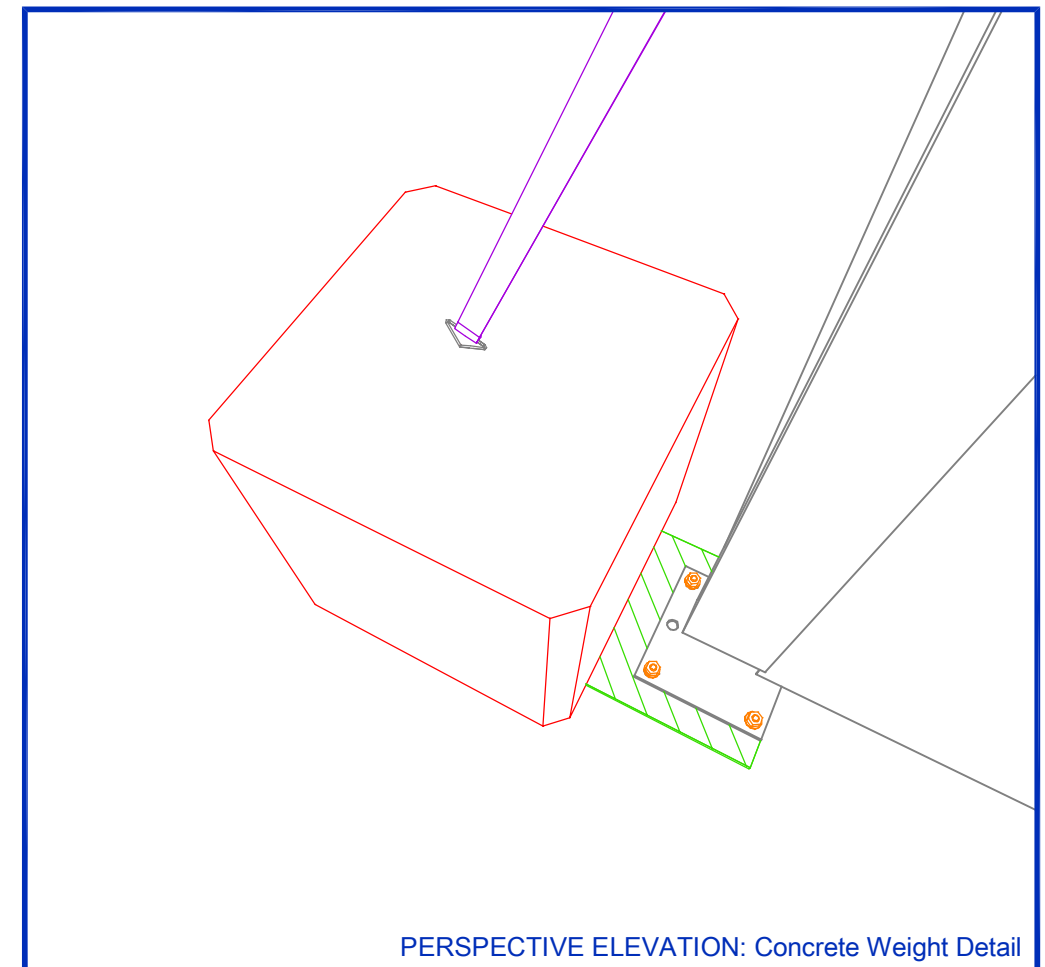

PERSPECTIVE ELEVATION: Concrete Weight Detail

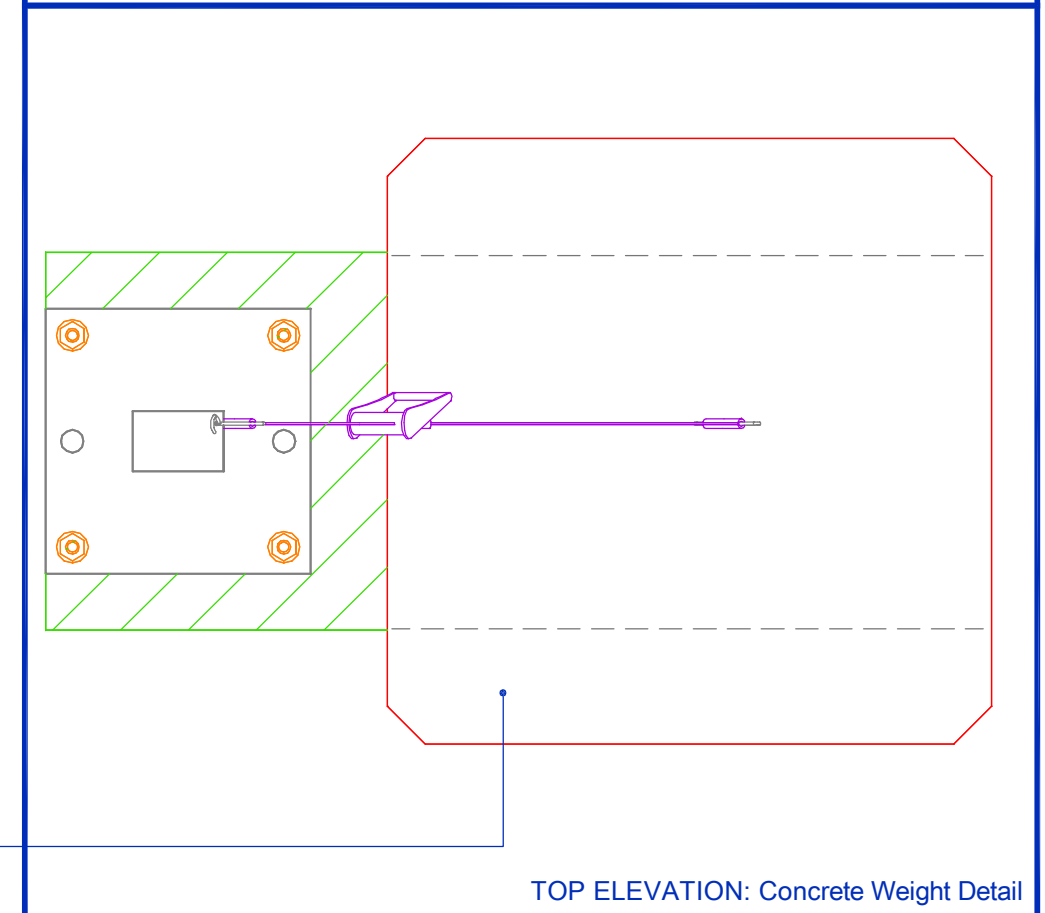

TOP ELEVATION: Concrete Weight Detail

20m STRUCTURE



Revised: James Weeding	Rev Date: 18/04/08	Revision: 2
Drawn: James Weeding	Dwn Date: 15/04/08	Scale: NTS A3
U:\Structures\...HRIA Structure Weighting Guidelines\HRIA Structure Weighting Guidelines.dwg		

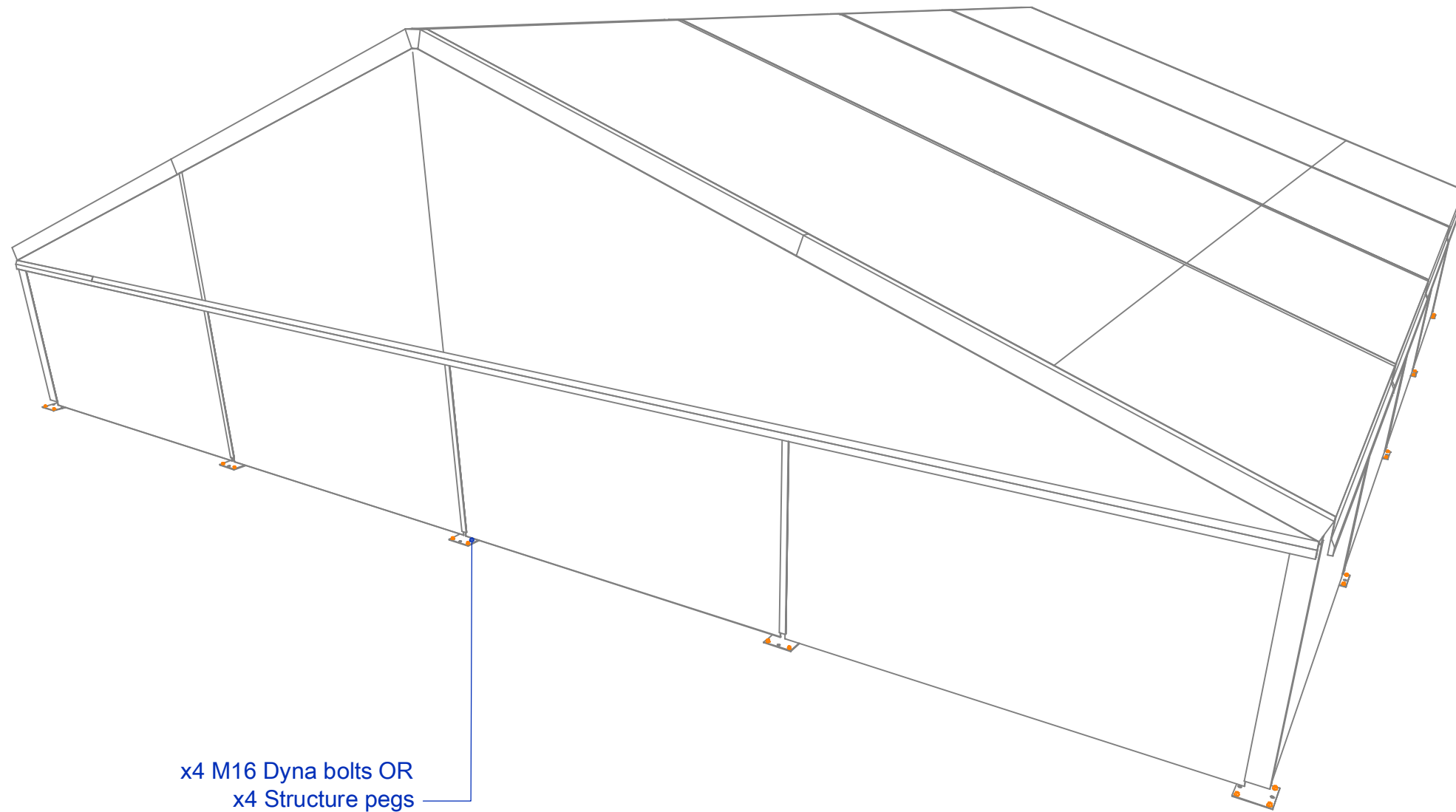

x4 M16 Dyna bolts OR
x4 Structure pegs
every footplate

M16 Dyna bolts minimum
embedment 85mm

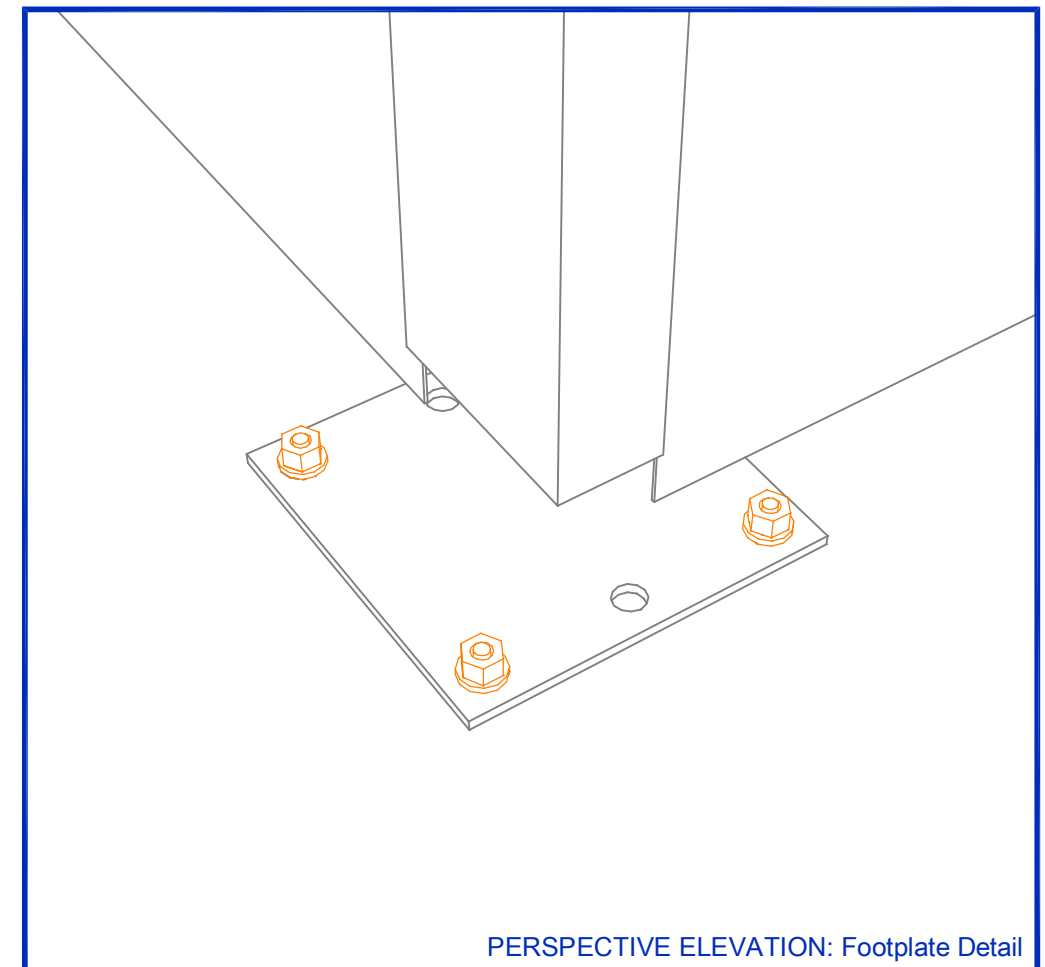

PERSPECTIVE ELEVATION: Footplate Detail

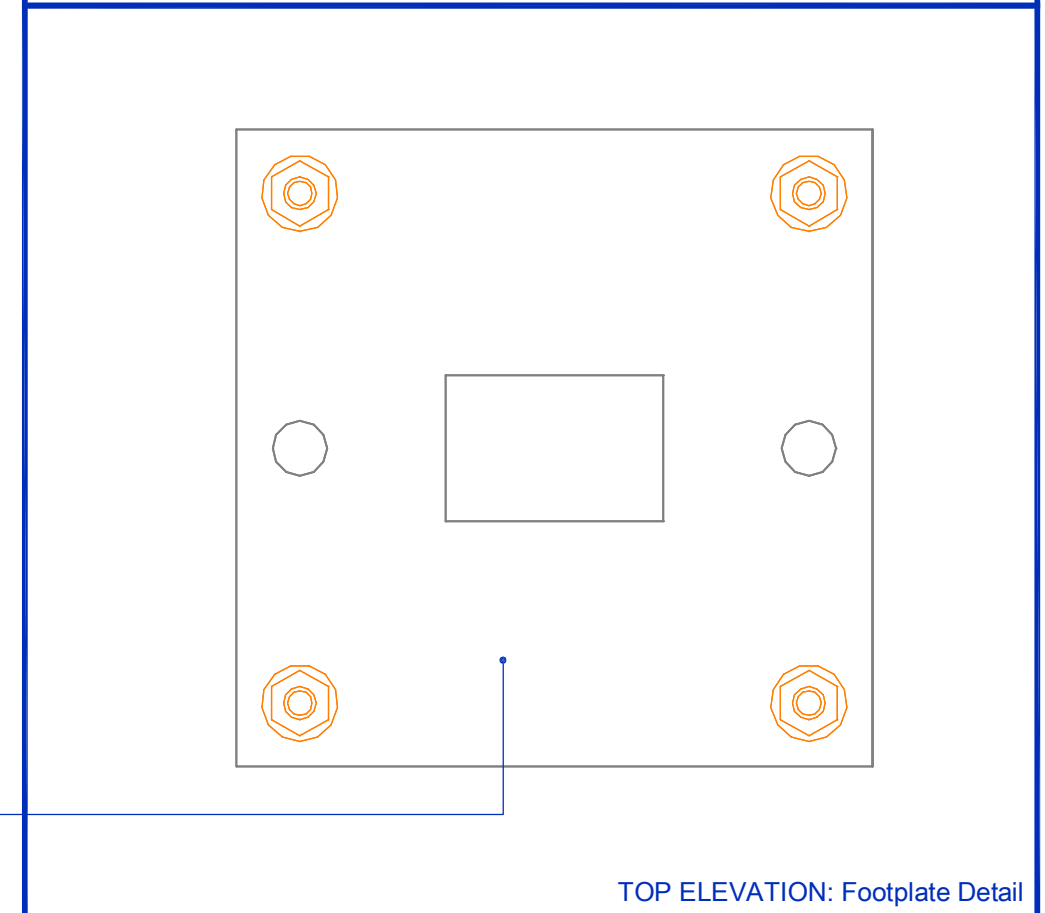

TOP ELEVATION: Footplate Detail

20m STRUCTURE (2)



Revised: James Weeding	Rev Date: 18/04/08	Revision: 2
Drawn: James Weeding	Dwn Date: 15/04/08	Scale: NTS A3
U:\Structures\...HRIA Structure Weighting Guidelines\HRIA Structure Weighting Guidelines.dwg		

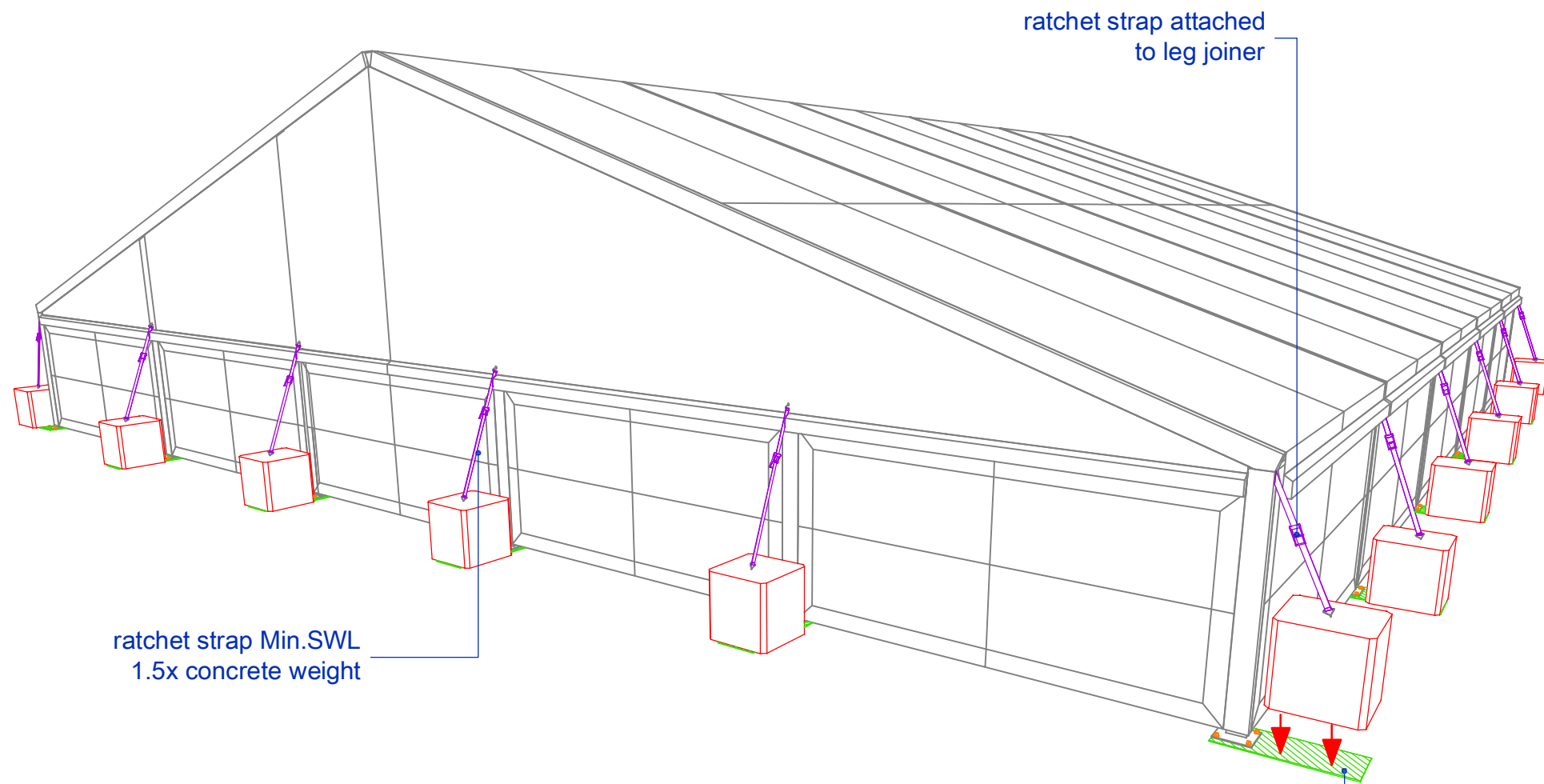

ratchet strap Min.SWL
1.5x concrete weight

weight sits on plate
bolted to footplate

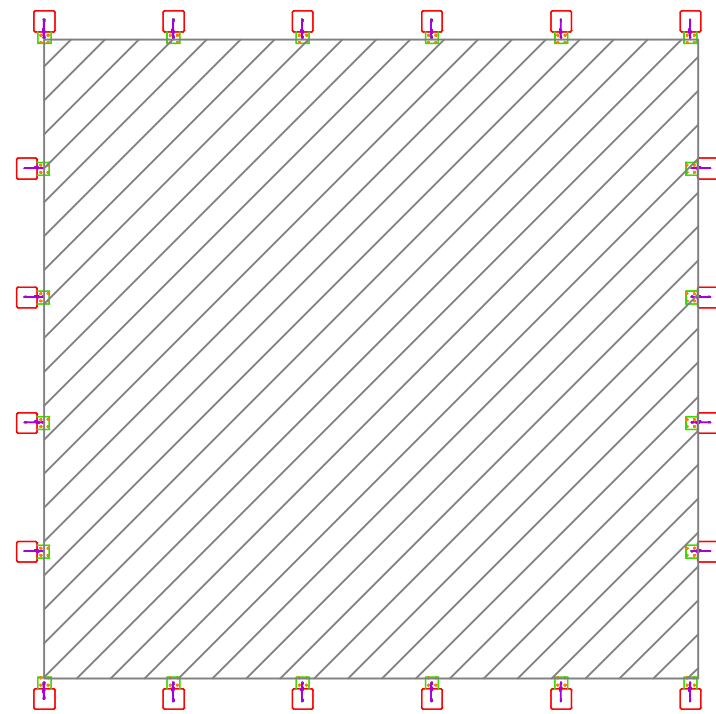

x1 weight per leg refer table
for weight requirements

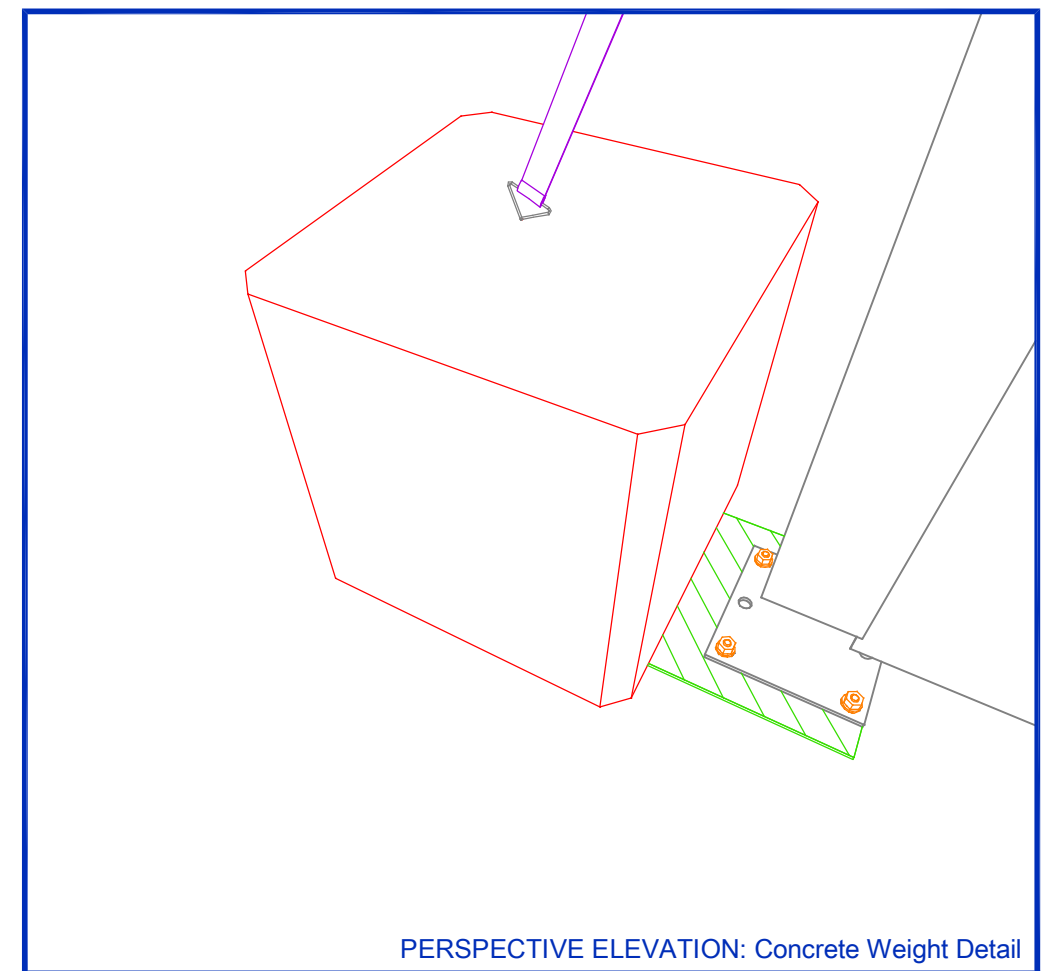

PERSPECTIVE ELEVATION: Concrete Weight Detail

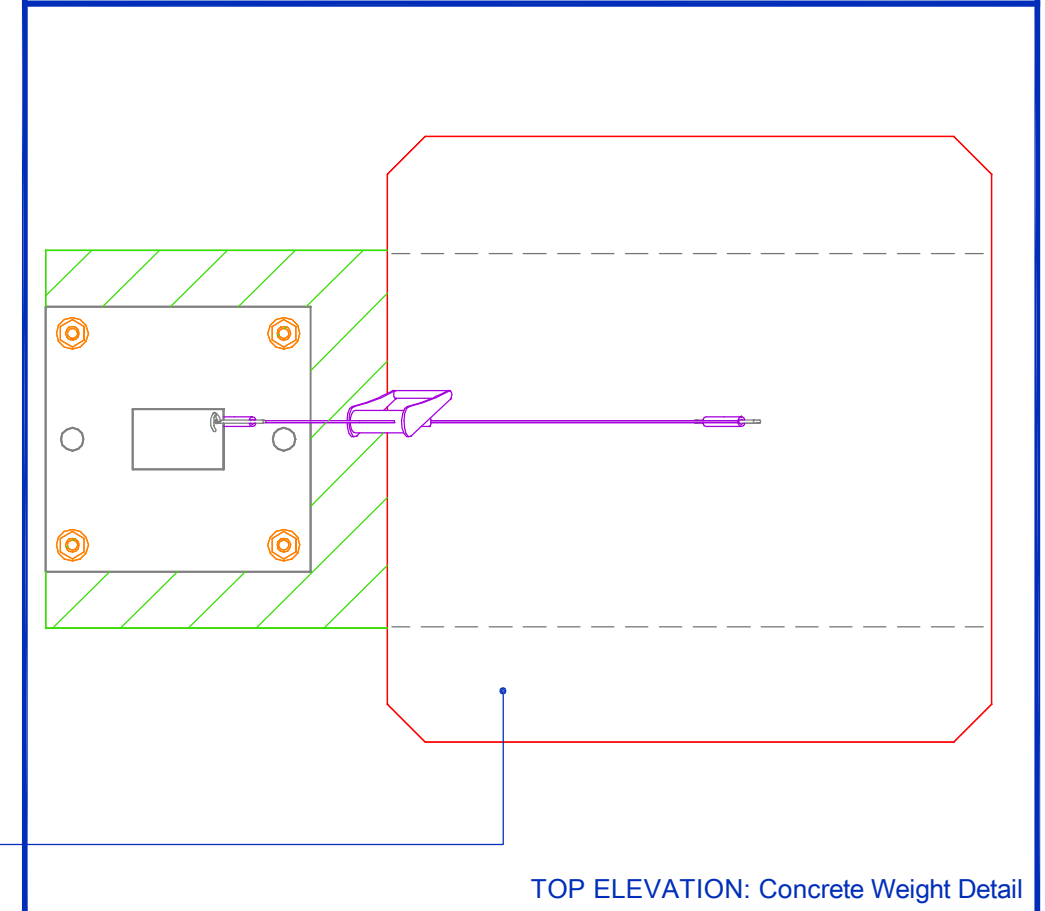

TOP ELEVATION: Concrete Weight Detail

25m STRUCTURE



Revised: James Weeding	Rev Date: 18/04/08	Revision: 2
Drawn: James Weeding	Dwn Date: 15/04/08	Scale: NTS A3
U:\Structures\...HRIA Structure Weighting Guidelines\HRIA Structure Weighting Guidelines.dwg		

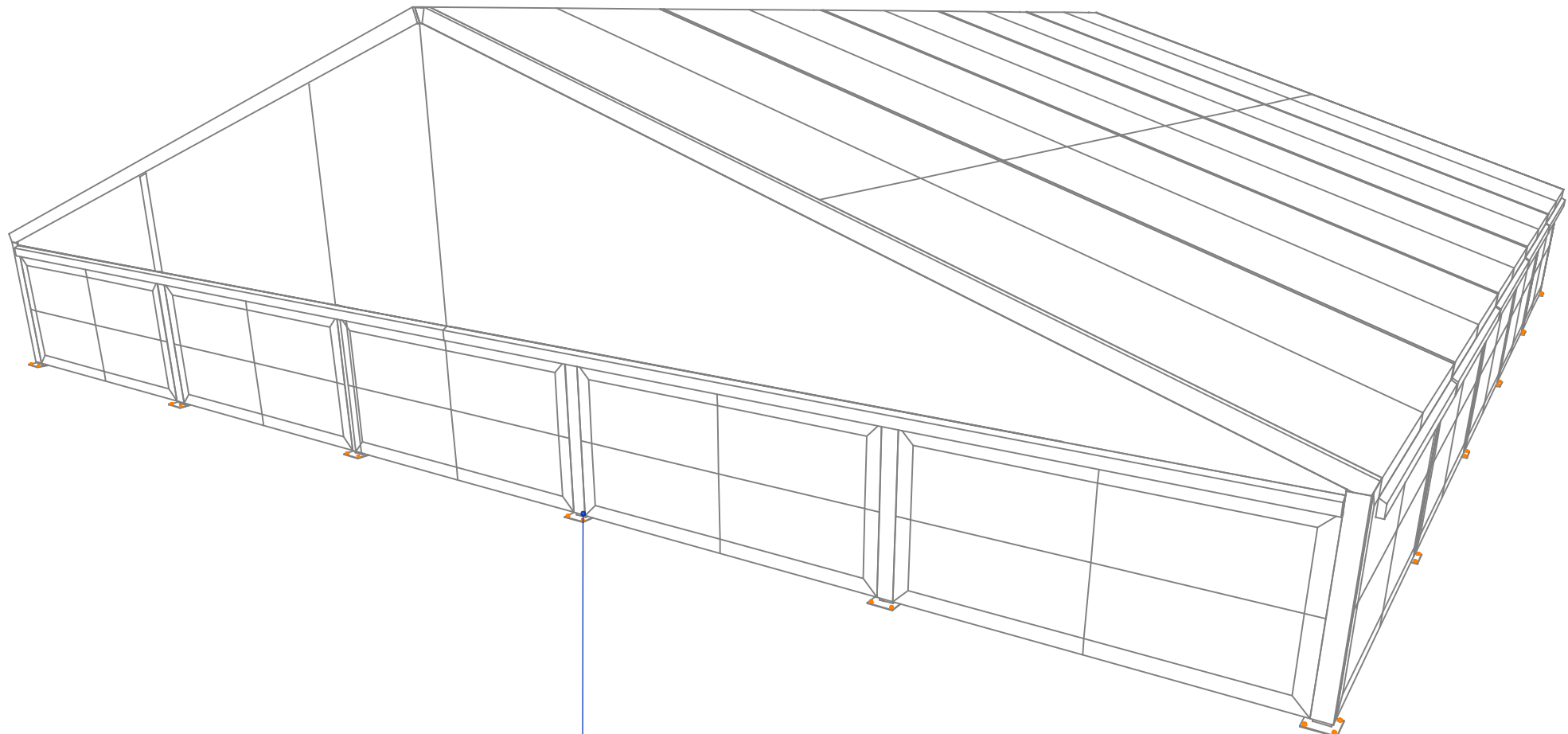

x4 M16 Dyna bolts OR
x4 Structure pegs
every footplate

M16 Dyna bolts minimum
embedment 85mm

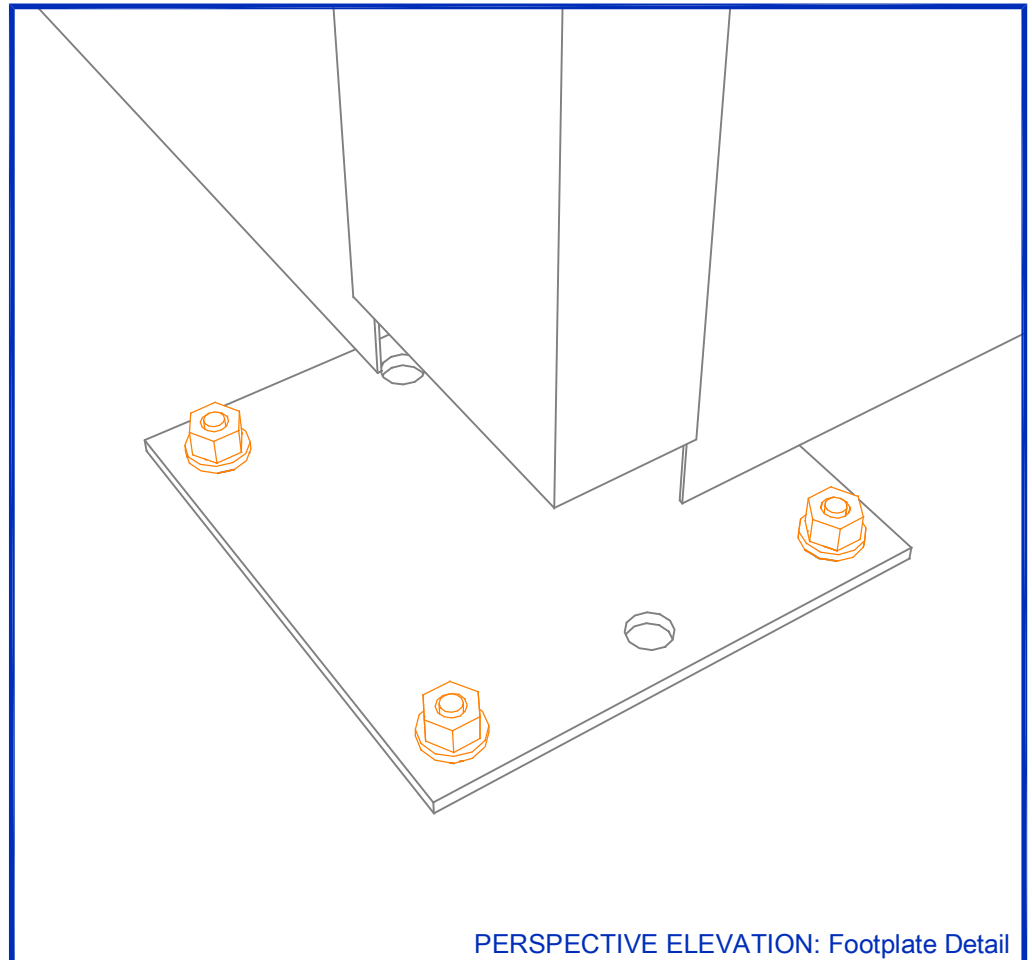

PERSPECTIVE ELEVATION: Footplate Detail

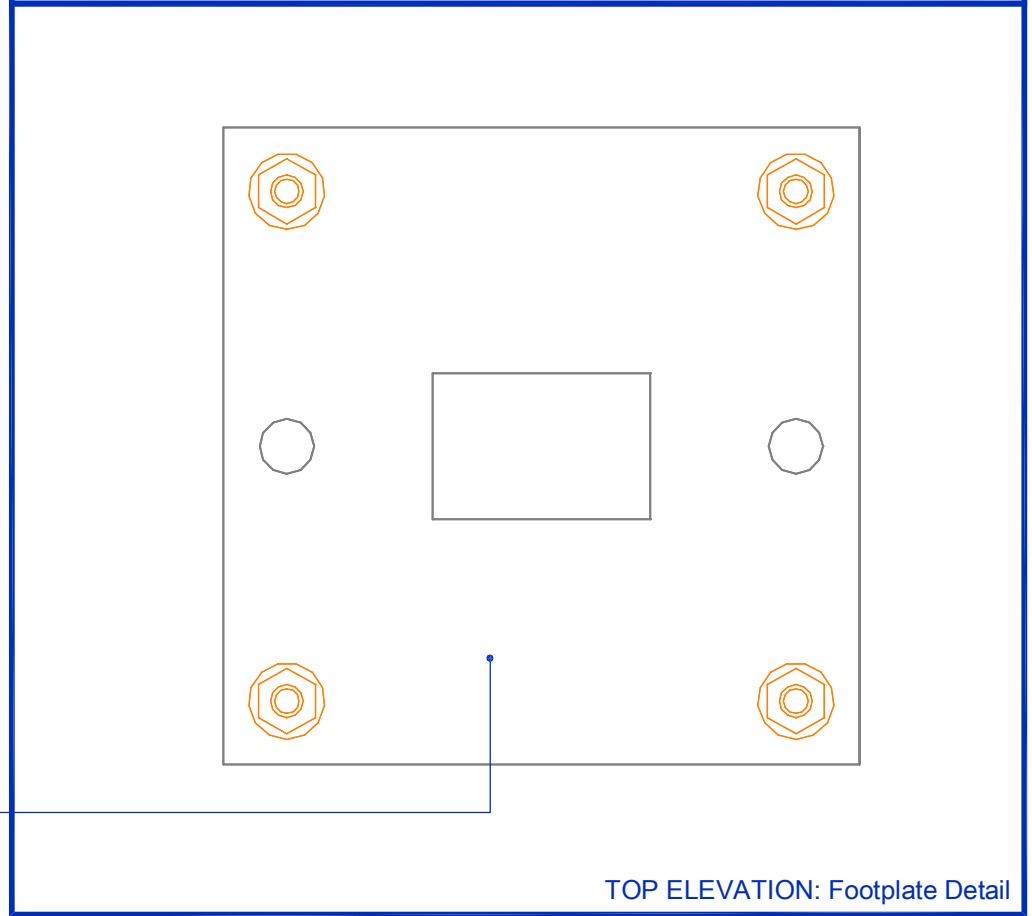

TOP ELEVATION: Footplate Detail

25m STRUCTURE (2)



Revised: James Weeding	Rev Date: 18/04/08	Revision: 2
Drawn: James Weeding	Dwn Date: 15/04/08	Scale: NTS A3
U:\Structures\...HRIA Structure Weighting Guidelines\HRIA Structure Weighting Guidelines.dwg		



